



H2000 Series Operation Manual



Thank you for choosing the general-purpose inverter of H2000 series of multi-functions and high performance made by GUANG ZHOU HAITEC TRANSMISSION EQUIPMENT Co., Ltd.

Incorrect handling might cause an unexpected fault. Before using the inverter, always read this instruction manual and the instruction manual packed with the product carefully to use the equipment to its optimum.

Do not attempt to install, operate, maintain or inspect the inverter until you have read through instruction manual and appended documents carefully and can use the equipment correctly. Do not use the inverter until you have a full knowledge of the equipment, safety information and instructions. In this instruction manual the safety instruction levels are classified into “Danger” and “Warning”, please pay special attention to the symbols “ Danger ” and “ Warning” and their relevant contents.

“ Danger” Assumes that incorrect handling may cause hazardous conditions, resulting in death or severe injury.

“ Warning” Assumes that incorrect handling may cause hazardous conditions, resulting in medium or slight injury, or may cause physical damage only.

The figures in this instruction manual are for convenience with description, they may have slight differences compared to the product, and the product update can also cause slight differences between the figure and product, the actual sizes are subject to actual products.

Please read carefully the operation manual before putting the inverter to use so as to correctly install and operate the inverter, give full play to its functions and ensure the safety. Please keep the operation manual handy for future reference, maintenance, inspection and repair.

If you have any questions, please contact us or our agents in time, you will always receive our best attention.

Contents

Chapter 1 Safety Cautions	1
1-1 Confirmation on receiving	1
1-2 Transportation and installation	1
1-3 Wiring and Junction	3
1-4 Power-on, Test operation	4
1-5 Inspection and Maintenance	5
1-6 Emergency stop	6
1-7 Disposing of the inverter	6
Chapter 2 Product Introduction	7
2-1 Unpacking Confirmation	7
2-2 Inverter model description	7
2-3 Product Specifications	8
2-4 Product storage	9
Chapter 3 Installation of the Inverter	11
3-1 Installation environment and requirements	11
3-2 Inverter outline dimension drawings.....	13
Chapter 4 Wiring	14
4-1 Main Circuit Wiring	15
4-1-1 Peripheral Devices Description	15
4-1-2 Main Circuit Wiring Notice	15
4-1-3 Peripheral Devices Specifications	17
4-1-4 Specification of main circuit terminal	18

4-2 Control circuit terminal	19
4-2-1 Basic wiring diagram	19
4-2-2 Control terminals layout (0.4~1.5kW)	19
4-2-3 Control circuit terminals description	19
4-2-4 Wiring instructions	21
Chapter 5 Operation	22
5-1 Opeation panel	23
5-1-1 Key Function description	23
5-1-2 Displays description	23
5-2 Operating panel operation instruction	24
Chapter 6 Table of Function Parameters	27
Chapter 7 Detailed Explanations of Functional Parameters ...	42
7-1 Parameters for monitoring	42
7-2 Basic parameters	46
7-3 Parameters of basic applications	57
7-4 Parameters for input and output application	63
7-5 Secondary application group	80
7.5 Special operation (PLC Control)	90
7-7 Special operation (PID Control)	97
7-8 Initial settings and specifications of RS-485 communication	104
7-9 Advanced application parameters	111
Chapter 8 Precautions for Maintenance and Inspection	114
8-1 Inspection	114
8-1-1 Daily inspection	114

8-1-2 Periodic inspection	114
8-1-3 Daily and periodic inspection.....	115
8-2 Replacement of parts	116
8-3 Trouble shooting.....	116
8-3 Check first when you have troubles	120
8-4 Inverter-generated noises and their reduction techniques	122
Chapter 9 Peripheral Devices Selection.....	124
9-1 Peripheral Devices Description	124
9-2 Applied Braking resistor Specification	125
Appendix 1 Simple Application Example	126

Chapter 1 Safety Cautions

1-1 Confirmation on receiving



The inverter has been strictly and well packed before ex-work . Inconsideration of various factors during the transportation special attention should be paid to the following points before the assembly and installation. If there is anything abnormal please notify the dealer or the relevant people of our company.

- Check if the inverter has got any damage or deformation during the transportation and handling.
- Check if there is one piece of H2000 series inverter and one copy of the instruction manual available when unpacking it.
- Check the information on the nameplate to see if the specifications meet your order (Operating voltage and KVA value).
- Check if there is something wrong with the inner parts, wiring and circuit board.
- Check if each terminal is tightly locked and if there is any foreign article inside the inverter.
- Check if the operator buttons are all right.
- Check if the optional components you ordered are contained.
- Check if there is a certificate of qualification and a warranty card.

1-2 Transportation and installation



- When carrying products, use correct lifting gear to prevent injury.
- Do not stack the inverter boxes higher than the number



recommended.

- Ensure that installation position and material can withstand the weight of the inverter. Install according to the information in the instruction manual.
- Do not install or operate the inverter if it is damaged or has parts missing.
- When carrying the inverter, do not hold it by the front cover or setting dial. It may fall or fail.
- Do not stand or rest heavy objects on the product.
- Check the inverter mounting orientation is correct.
- Prevent other conductive bodies such as screws and metal fragments or other flammable substance such as oil from entering the inverter.
- As the inverter is a precision instrument, do not drop or subject it to impact.
- Use the inverter under the following environmental conditions. Otherwise, the inverter may be damaged.

Ambient temperature: $-10^{\circ}\text{C}\sim 40^{\circ}\text{C}$ <non-freezing>.

Ambient humidity: 95% RH or less <non-condensing>

Ambient environment: indoors <free from corrosive gas, flammable gas, oil mist, dust and dirt, free from direct sunlight>

Vibration: max. 0.5G

- Please make sure that the screws are fixed, fastened firmly in accordance with the stipulations of the instruction manual, to prevent the inverter falling.
- If two or more inverters are installed in a control cabinet, please install them according to the information in the instruction manual, and it is required to keep enough space and install extra cooling fans to keep the air in the cabinet flowing freely to keep the temperature inside the cabinet lower than 40°C . Overheating may cause inverter fault, fire or other accidents.
- Due to the inverter of a kind of electrical and electronic product

it must be installed, tested and adjusted with parameters by specialized engineering persons of motors.

1-3 Wiring and Junction

Warning

- Please do not damage the wires. Let the wires bear weight or be clamped may damage the wires and cause an electric shock.
- Do not install a power factor correction capacitor or surge suppressor/radio noise filter (capacitor type filter) on the inverter output side.
- Do not install switch devices such as the air switch and contactor on the inverter output side, if it is for technologic demand, please ensure that the inverter is switching without output.
- Wrong wiring might lead to damage of the inverter. The control signal lines must be kept fully away from the main circuit to protect them from noise.

Danger

- Please ensure that the power is off before junction.
- The wiring work shall be done by qualified electricians.
- Please wire the wires in accordance with the specifications stipulated in the instruction manual.
- The grounding connection shall be done correctly and in accordance with relative regulations in the instruction manual, otherwise it may cause an electric shock or fire.
- Please use independent power supply for the inverter, never use the same power supply with strong interference equipment like electric welder.
- Please do not touch the bottom plate with wet hand, otherwise you may get an electric shock.
- Please do not touch the terminals directly, do not connect the

inverter's input or output terminals to the inverter's shell, otherwise you may get an electric shock.

- Please make sure that the voltage of the power supply and the voltage of the inverter are same, otherwise it may cause the inverter fault or personnel injury.
- The power supply cables must be connected to R,S,T. Never connect the power cable to the U,V,W of the inverter. Doing so will damage the inverter.
- Please do not conduct pressure resistance test to the inverter, otherwise it may cause the inverter's internal fault.
- Please install accessories such as brake units, brake resistors in accordance with the regulations of the instruction manual, otherwise it may cause the inverter fault or fire.
- Please ensure that the screws of the terminals are firmly locked, otherwise it may cause the inverter fault.

1-4 Power-on, Test operation

Warning

- While power is on or when the inverter is running, do not open the front cover. Otherwise you may get an electric shock.
- Do not run the inverter with the front cover or wiring cover removed. Otherwise, you may access the exposed high-voltage terminals or the charging part of the circuitry and get an electric shock.
- Before starting operation, confirm and adjust the parameters. A failure to do so may cause some machines to make unexpected motions.
- It is recommended to undertake test runs with no load.
- Please provide an emergency stop switch when the "stop" function setting is unavailable.
- Do not use the inverter input side magnetic contactor to start/stop

the inverter, otherwise it may affect the life of the inverter.

 **Danger**

- When fault restart function is set, please do not approach the equipment because the equipment may automatically restart after the running stop.
- Make sure that the specification and rating match the system requirements. Exceeding their use range can cause motor and machine fault.
- Please do not change the parameter settings of inverter casually during running.
- While power is on or for some time after power-off, do not touch the inverter as it is hot and you may get burnt.
- Perform setting dial and key operations with dry hands to prevent an electric shock. Otherwise you may get an electric shock.
- Please do not link or withdraw motors during the inverter running, otherwise it may cause inverter protection or fault.

1-5 Inspection and Maintenance

 **Warning**

- Please ensure that the power supply and the power indicating light is off before inspecting and maintaining. Otherwise you may get an electric shock.
- For prevent damage due to static electricity, touch nearby metal before touching this product to eliminate static electricity from your body.
- Do not carry out a megger (insulation resistance) test on the control circuit of the inverter.

 **Danger**

- Any person who is involved in the wiring or inspection of this equipment should be fully competent to do the work.
- Please do check, maintenance and replacement of the components according to the appointed methods in the instruction manual, strictly prohibit modifying by yourself. If you do so, you may get an electric shock and injury or the inverter may get damaged.

1-6 Emergency stop



- Provide a safety backup such as an emergency brake which will prevent the machine and equipment from hazardous conditions if the inverter fails.
- When the breaker on the inverter input side trips, check for the wiring fault (short circuit), damage to internal parts of the inverter, etc. Identify the cause of the trip, then remove the cause and power on the breaker.
- When the protective function is activated, take the corresponding corrective action, then reset the inverter, and resume operation.

1-7 Disposing of the inverter



Treat as industrial waste. Do not burn it up!

Chapter 2

Product Introduction

2-1 Unpacking Confirmation

In unpacking, please confirm the following:

- Check whether the model type of the inverter is in accordance with your order.
- Check whether the inverter is damaged and related accessories are included.

If you find an omission or disagreement, please contact the suppliers.

2-2 Inverter model description

MODE: H2200A01D5K

INPUT: 1PH 220V 50Hz / 60Hz

OUTPUT: 3PH 220V 7.0A 150% 60S

FREQ RANGE: 0.1-400HZ 1.5KW



OTS 201D5A0902070

GUANG ZHOU HAITEC TRANSMIAAION EQUIPMENT CO.,LTD

Model: H 2 200 A 01D5 K3052

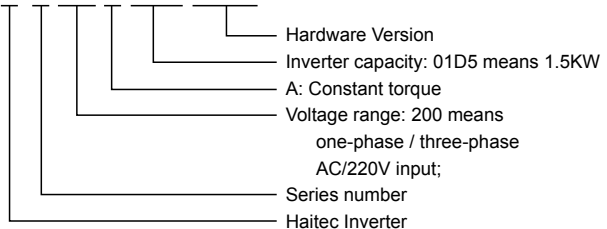

2-3 Product Specifications

Items		H2000
Power Supply	Rated voltage, Frequency	One-phase/Three-phase 220V 50/60Hz
	Voltage Range	220V: 170V~240V
Output	Voltage Range	220V: 0~220V
	Frequency Range	0.10~400.00Hz
Control method		V/F control, Space vector control.
Indication		Operating status/Alarm definition/interactive guidance: eg, frequency setting, the output frequency/current, DC bus voltage, the temperature and so on.
Control Specifications	Output Frequency Range	0.10Hz~400.00Hz
	Frequency Setting Resolution	Digital input : 0.01 Hz, analog input: 0.1% of maximum output frequency
	Output Frequency Accuracy	0.01Hz
	V/F Control	Setting V/F curve to satisfy various load requirements.
	Torque Control	Auto increase: auto raise torque by loading condition; Manual increase:enable to set 0.0~20.0% of raising torque.
	Multifunctional Input Terminal	Six multi-function input terminals, realizing functions including fifteen section speed control, program running, four-section acceleration/ deceleration speed switch, UP/DOWN function and emergency stop and other functions
	Multifunctional Output Terminal	2 multi-function output terminals for displaying of running, zerospeed, counter, external abnormality, program operation and other information and warnings.
	Acceleration/ deceleration Time Setting	0~999.9s acceleration/deceleration time can be set individually.

	Items	H2000
Other Functions	PID Control	Built-in PID control
	RS485	Standard RS485 communication function (MODBUS)
	Frequency Setting	Analog input:0 to 10V, 0 to 20mA can be selected; Digital input: Input using the setting dial of the operation panel or RS485or UP/DOWN.
	Multi-speed	Six multifunction input terminals, 15 section speed can be set
	Automatic voltage regulation	Automatic voltage regulation function can be selected
	Counter	Built-in 2 group of counters
Protection/Warning Function	Overload	150%, 60second (Constant torque)
	Over Voltage	Over voltage protection can be set.
	Under Voltage	Under voltage protection can be set.
	Other Protections	Overheat ,output shortcircuit , over current, and parameter lock and so on.
Environment	Ambient Temperature	-10°C to 40°C (non-freezing)
	Ambient Humidity	Max. 95% (non-condensing)
	Altitude	Lower than 1000m
	Vibration	Max. 0.5G
Structure	Cooling Mode	Forced air cooling
	Protective Structure	IP 20
Installation	Mode	Wall Mounted

2-4 Product storage

The inverter must be put in the packaging box before installation.If the inverter is not used for the moment, during the storage, please

pay attention those as below:

1. The products must be placed in the location with dry and without dust and dirt.
2. The relative humidity of the environment is within 0~95%, and without condensing.
3. The storage temperature of the environment must be within the range of -26°C to +65°C.
4. There are no corrosive gas and liquids in the storage environment, and the product is away from direct sunlight.

It is better not to store the inverter for long time. Long time storage of the inverter will lead to the deterioration of electrolytic capacity. If it needs to be stored for a long time make sure to power it up one time within a year and the power-up time should be at least above five hours. When powered up the voltage must be increased slowly with a voltage regulator to the rated voltage value.

Chapter 3

Installation of the Inverter

3-1 Installation environment and requirements

Environment of installation has direct effect on the inverter's life. If the inverter is used in the environment that does not accord with the allowed range of the operation instruction, and may lead to the inverter protection or fault.

About the inverter's installation environment, please ensure it is in accordance with the following condition:

- (1) Environment temperature from -10°C to $+40^{\circ}\text{C}$
- (2) Environment humidity 0~95% without condensing
- (3) Away from direct sunlight
- (4) The environment does not contain corrosive gas and liquid
- (5) The environment does not contain dust, floating fiber and metal dust.
- (6) Far away from radioactive materials and combustible substances
- (7) Far away from electromagnetic interference sources (as welder, high-powered machines)
- (8) The installation surface shall be firm. Without vibration, the vibration cannot be avoided, please add anti-vibration spacer to reduce vibration.
- (9) Please install the inverter to a location where it is good for ventilation, inspection and maintenance, and away from heating unit (as brake resistor).
- (10) Preserved enough space for inverter installation, especially for multiple inverters installation, please pay attention to the laying position of the inverter, and install an extra cooling fan to keep the environment temperature lower than 45°C .

① Single inverter installation

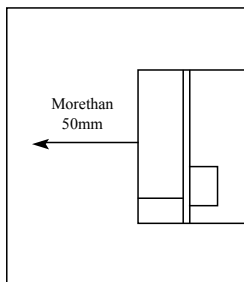
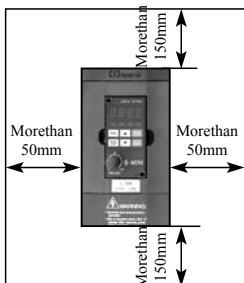

② Multiple inverters installed in one control cabinet.

Please pay attention: When encasing the multiple inverters, install them in parallel as a cooling measure.

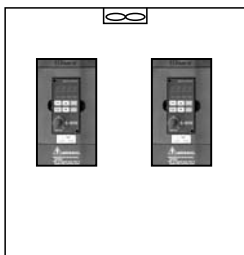

Favorable placing

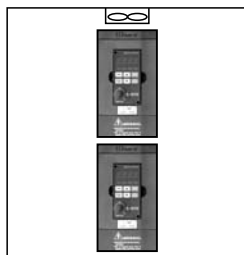

Unfavorable placing

③ If multiple inverters are installed in one control cabinet, please leave enough clearances and take cooling measure.

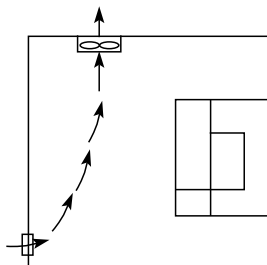

Correct installation position of the fan

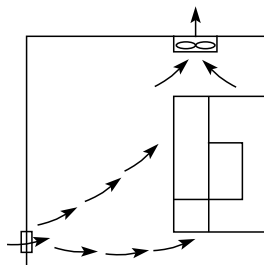

Incorrect installation position of the fan

3-2 Inverter outline dimension drawings

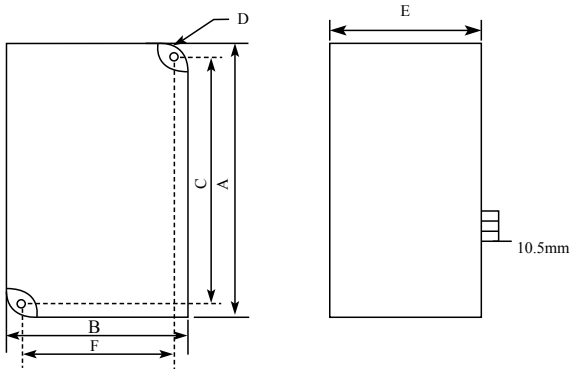

Unit: mm

Model	A	B	C	$\varnothing D$	E	F
H2200A00D4K	141.5	85.0	130.5	5.0	113	74
H2200A00D7K	141.5	85.0	130.5	5.0	113	74
H2200A01D5K	141.5	85.0	130.5	5.0	113	74

Chapter 4 Wiring

The wiring of the inverter can be divided into main circuit and control circuit.

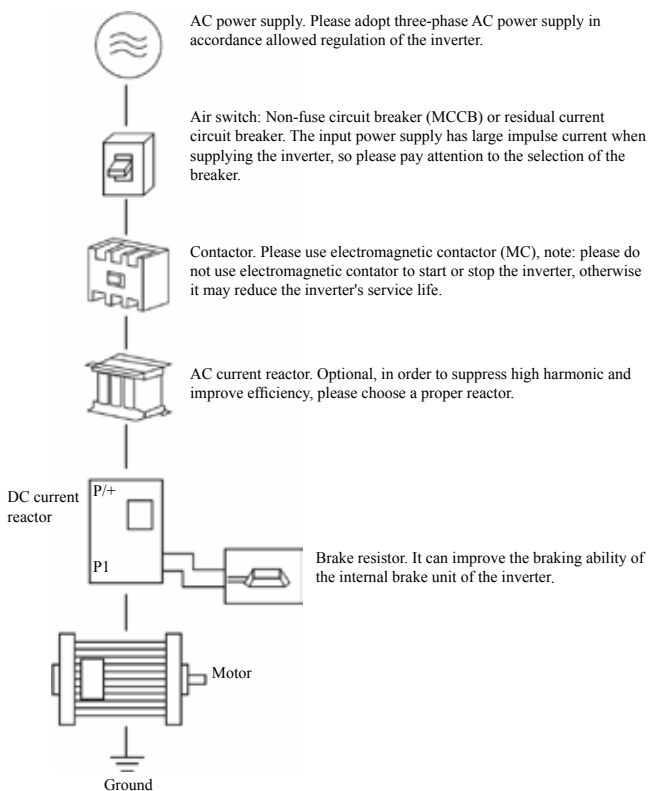

4-1 Main Circuit Wiring

4-1-1 Peripheral Devices Description

(1) AC power supply

Use within the permissible power supply specifications of the inverter.

(2) Moulded case circuit breaker: (MCCB)

When the power supply voltage is low or the input terminal short circuit occurs, the breaker can provide protection, during inspection, maintenance or the inverter is not running, you can cut off the breaker to separate the inverter from the power supply.

(3)Magnetic contractor(MC)

The contractor can turn on and turn off the power of the inverter to ensure safety.

(4) AC current reactor

a: Suppress high harmonic to protect the inverter.

b: Improve the power efficiency.

(5) Brake resistor

When the motor is braking, the resistor can avoid DC bus high voltage of the inverter, and improve the braking ability of the internal brake unit.

15KW or less the brake unit is built-in, please confirm it.

To select the brake resistor, please refer to section 4, chapter 9:

Applied Braking resistor specification.

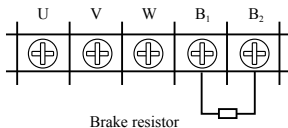

4-1-2 Main Circuit Wiring Notice

The H2000 series is a highly reliable product, but incorrect peripheral circuit making or operation/handling method may shorten the product life or damage the product.

Before starting operation , always recheck the following items.

- (1) Use crimping terminals with insulation sleeve to wire the power supply and motor.
- (2) Application of supply power to the output terminals (U,V,W)of the inverter will damage the inverter . Never perform such wiring.
- (3) After wiring, wire offcuts must not be left in the inverter.
Wire offcuts can cause an alarm ,failure or malfunction . Always keep the inverter clean . When drilling mounting holes in an enclosure etc., take care not to allow chips and other foreign matter to enter the inverter.
- (4) This inverter must be earthed . Earthing must conform to the requirements of national and local safety regulations and electrical codes .
- (5) Use the thickest possible earth cable.
- (6) The grounding point should be as near as possible to the inverter , and the ground wire length should be as short as possible.
- (7) Where possible , use independent earthing for the inverter .
If independent earthing is impossible , use joint earthing (I , II) where the inverter is connected with the other equipment at an earthing point . Joint earthing as in (III) must be avoided as inverter is connected with the other equipment by a common earth cable .

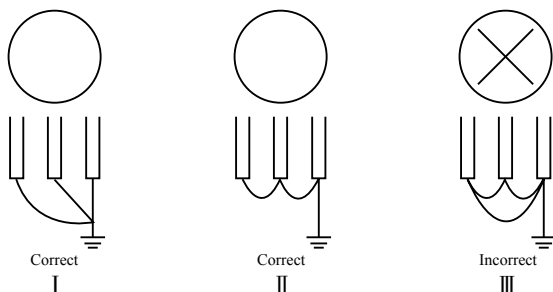

- (8) To prevent a malfunction due to noise , keep the signal cables more than 10 cm away from the power cables .

(9) The overall wiring length should be 100 m maximum.

Especially for long distance wiring, the fast-response current limit function may be reduced or the equipment connected to the inverter output side may malfunction or become faulty under the influence of a charging current due to the stray capacity of the wiring. Therefore, note the overall wiring length.

(10) Do not install a power factor correction capacitor, surge suppressor or radio noise filter on the inverter output side.

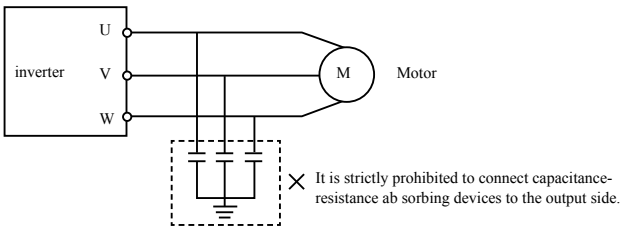

(11) Before starting wiring or other work after the inverter is operated, wait for at least 10 minutes after the power supply has been switched off, and check that there are no residual voltage using a tester or the like. The capacitor is charged with high voltage for some time after power off and it is dangerous.

(12) Electromagnetic wave interference

The input/output (main circuit) of inverter includes high frequency components, which may interfere with the communication devices (such as AM radios) used near the inverter. In this case, set the EMC filter valid to minimize interference.

(13) Across P/+ and PR terminals, connect only an external regenerative brake discharge resistor. Do not connect a mechanical brake.

4-1-3 Peripheral Devices Specifications

Check the motor capacity of the inverter you purchased.

Appropriate peripheral devices must be selected according to

the capacity. Refer to the following list and prepare appropriate peripheral devices:

Applicable Inverter Type	Input voltage	Motor Output (kW)	Main Circuit Cable Type (mm ²)	Breaker Selection (A)	Input Side Magnetic contractor (A)
H2200A00D4K	220V	0.4	2.5	16	12
H2200A0D75K	220V	0.75	2.5	16	12
H2200A01D5K	220V	1.5	2.5	32	18

*The above data are for reference only.

4-1-4 Specification of main circuit terminal

The arrangement of main circuit terminals is shown below:

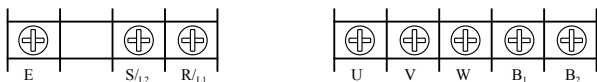

Terminal Symbol	Terminal Name	Description
R,S,T	AC power input	Connect to the commercial power supply.
U,V,W	Inverter output	Connect a three-phase motor.
B ₁ , B ₂	Brake resistor connection	Connect brake resistor.
⏏ E	Earth (ground)	For earthing (grounding) the inverter chassis. Must be earthed (grounded).

Cable connection examples

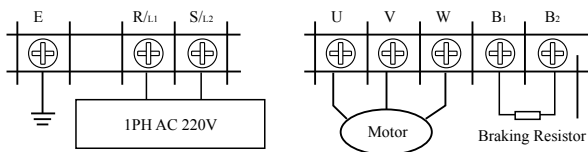

4-2 Control circuit terminal

4-2-1 Basic wiring diagram

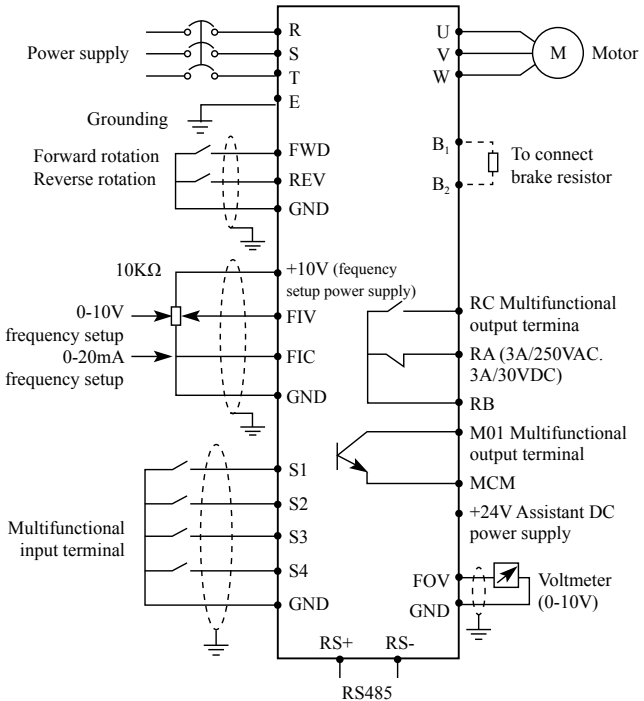

4-2-2 Control terminals layout (0.4~1.5kW)



4-2-3 Control circuit terminals description

Indicates that terminal functions can be selected using P315 to P329. (I/O terminal function selection)

(1) Input signals

Type	Terminal Symbol	Terminal Name	Description	Refer to page
Contact input	FWD	Forward rotation start	Turn on the FWD signal to start forward rotation and turn it off to stop.(multifunctional input terminal)	35
	REV	Reverse rotation start	Turn on the REV signal to start reverse rotation and turn it off to stop.(multifunctional input terminal)	35
	S1		multifunctional input terminal 1	35
	S2		multifunctional input terminal 2	35
	S3		multifunctional input terminal 3	35
	S4		multifunctional input terminal 4	35
Frequency setting	+10V	Frequency setting power supply	Frequency setting power supply.(FIV, FIC)	36
	FIV	Frequency setting(voltage)	Inputting 0 to 10VDC provides the maximum output frequency at 10V and makes input and output proportional.	36
	FIC	Frequency setting(current)	Inputting 0 to 20mADC provides the maximum output frequency at 20mA and makes input and output proportional.	36
	GND	Frequency setting common	Common terminal for terminals FIV, FIC, +10V, and analog output terminal FOV, FOC	36

(2) Output signals

Type	Terminal Symbol	Terminal Name	Description	Refer to page
Contact output	MO1	Multifunction output terminal (optical coupling)	Permissible load 24VDC 0.1A	36
Contact output	RA	Relay out 1	Abnormal: No conduction across YA-YB (Across YB -YC continuity), Nor-mal: No conduction across YC-YB (Across YB-YA continuity). Contact capacity: 250VAC / 3A, 30VDC / 3A	36
	RB			
	RC			

Type	Terminal Symbol	Terminal Name	Description	Refer to page
Analog output	FOV	Analog voltage output	Output signal 0 to 10VDC, permissible load current 1mA. The output signal is proportional to the output frequency.	36

(3)Communication

RS485	RS+	Frequency setting(current)	With the RS+,RS-,connector,communication can be made through RS486.	36
	RS_	Frequency setting common		36

4-2-4 Wiring instructions

- (1) Use shielded or twisted cables for connection to the control circuit terminals and run them away from the main and power circuits (including the 200V relay sequence circuit).
- (2) Use two or more parallel micro-signal contacts or twin contacts to prevent a contact faults when using contact inputs since the control circuit input signals are micro-currents.
- (3) Do not apply a voltage to the contact input terminals of the control circuit .
- (4) Always apply a voltage to the alarm output terminals (RA, RB, RC, MO1) via a relay coil ,lamp , etc.
- (5) It is recommended to use the cables of 0.75m m² gauge for connection to the control circuit terminals.
- (6) The wiring length should be 30m maximum.

Chapter 5 Operation

The digital manipulator is located at the center of the inverter, and it is divided into two parts: displaying part and key control part. The displaying part indicates the parameter setting and different operation status, and the key control part is the communication channel between the user and the inverter.

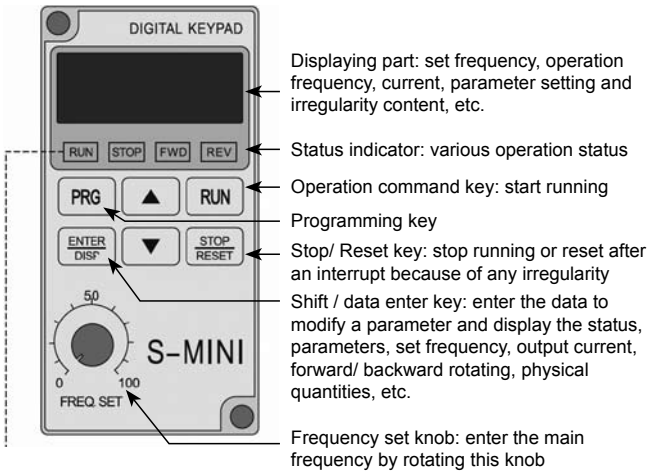



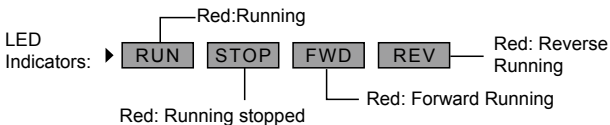



LED indicators:





5-1 Opeation panel

5-1-1 Key Function description

Key Symbol	Function description
	Function selecting key, for select a function menu
	Figure modifying key, for modify a function code and parameter
	Shift key or enter key Shift to an another digit or switch to another display by short-pressing, confirm a setting by long-pressing
	Turn to another frequency by rotating the potentiometer when the frequency is set to be controlled by the manipulator potentiometer
	Command for running
	Command for stopping (applicable in the manipulator controlled status) or reset after an fault

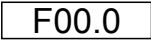
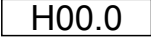
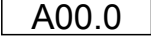
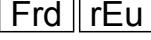

















5-1-2 Displays description

	Display item	Description
1		Frequency setting after the power supply is switched on
2		Actual running frequency
3		Current for motor running
4		Motor rotating direction

* The above display items can be switched and read by short pressing the  key on the main menu.

5-2 Operating panel operation instruction

(1) Parameter setting <taking modifying P104 reverse Valid setup as example>

Program	Key name	Display	Description
1	Power on	 F00.0	① Display the frequency setting (initial display). ② The inverter is standing by.
2	Press 	 P000	To enter the parameter setup state, and the first letter blinks (means modifiable item)
3	Press  for four times	 P004	The digit is modified into "4" from "0".
4	Quickly press  2 times (quick press means shift)	 P004	Shift leftward for two digits and the third digit will clicker.
5	Press  for once	 P104	The digit is modified into "1" from "0".
6	Press and hold 	 0001	Enter the parameter setting interface.
7	Press  	 0000	Modified "1" into "0".
8	Press and hold 	 P105	To confirm that the value "P104" has been modified.
9	Press 	 F00.0	Return back to the initial display.























Note:

- Pressing  can interrupt the modification and return back to the main display interface.
- When a modification is confirmed, An Err may be displayed to show the parameter modification is failed.

(2) Status display and inquiry

Parameter set: the frequency for the startup and shutdown (P102=0)

of the frequency converter controlled by the manipulator is given by the potentiometer of the manipulator (P101=3).

Step	Key name	Display	Description
1	Power on		Frequency setting display state.
2	Rotate 		Frequency Setting 5.0Hz.
3	Press 		Forward running of the frequency is turned on.
4	Press 		Switch to the actual running frequency display.
5	Rotate 		Modify the set frequency, and the actual running frequency is modified into 15Hz from 5Hz.
6	Press  for once		Switch to the current display when the current output is 0A.
7	Press  for once		Switch to the setting interface (press to switch the rotating direction)
8	Press  for once		Switch to the parameter setting status.
9	Press  for once		Select parameter code P006 to be modified.
10	Long press 		P006 content: the current temperature of the frequency converter is 22.8°C.
11	Press  for twice		Return back to the main display, the set frequency is 15Hz.
12	Press 		During the frequency converter is decelerating before stop, the key will flicker and then the and keys will turn on, and the set frequency displayed is 15Hz

Note: The set frequency, running frequency, output current and running speed of the frequency converter can be monitored by switching keys during operation, and the main display can be modified by P000 setting as per the practical requirement, and meanwhile the related content can be monitored by the user through P001-P018.

Chapter 6

Table of Function Parameters

This chapter explains the “PARAMETERS” for use of this product.

Always read this instructions before use.

Parameter list

Function	Parameters	Name	Setting Range	Minimum Setting increments	Initial value	Refer To Page
Monitor functions	P000	Main display data selection	0-32	1	1	47
	P001	Display the set frequency.	Read only	----	----	48
	P002	Display the output frequency	Read only	----	----	48
	P003	Display the output current	Read only	----	----	48
	P004	Display the motor speed.	Read only	----	----	48
	P005	Display the DC bus voltage value.	Read only	----	----	48
	P006	Display the temperature of inverter .	Read only	----	----	48
	P007	Display PID	Read only	----	----	49
	P010	Alarm record 1	Read only	----	----	49
	P011	Alarm record 2	Read only	----	----	49
	P012	Alarm record 3	Read only	----	----	49
	P013	Alarm record 4	Read only	----	----	49

Function	Parameters	Name	Setting Range	Minimum Setting increments	Initial value	Refer To Page
Monitor functions	P014	The frequency setting in the last alarm.	Read only	----	----	49
	P015	The output frequency in last alarm .	Read only	----	----	49
	P016	The output current in last alarm .	Read only	----	----	49
	P017	The output voltage in last alarm .	Read only	----	----	49
	P018	The output DC bus voltage in last alarm .	Read only	----	----	49
	P100	Digital frequency setting	0.00—Maximum frequency	0.01	0.00	50
P101	Frequency setting selection	0: Digital frequency setting (P100) 1: Analog voltage (0—10VDC) 2: Analog current (0—20mADC) 3. Setting dial (Operation panel) 4 UP/DOWN frequency setting 5: RS485 communication frequency setting	1	0	51	
Basic functions	P102	Start signal selection	0: Operation panel (FWD/REV/STOP) 1: I/O terminal 2: Communication (RS485)	1	0	53
	P103	“stop” key lock operation selection	0: “Stop”key lock mode invalid 1: “Stop” key lock mode valid	1	1	56

Chapter 6 Table of Function Parameters

Function	Parameters	Name	Setting Range	Minimum Setting increments	Initial value	Refer To Page
Basic functions	P104	Reverse rotation prevention selection	0: Reverse rotation disallowed 1: Reverse rotation allowed	1	1	57
	P105	Maximum frequency	Minimum frequency~400.00Hz	0.01	0.00	57
	P106	Minimum frequency	0.00~maximum frequency	0.01	0.00	57
	P107	Acceleration time 1	0~999.9s	0.1	Depends on models	58
	P108	Deceleration time 1	0~999.9s	0.1		58
	P109	V/F maximum voltage	V/F intermediate voltage ~500.0 V	0.1	400.0	58
	P110	V/F base frequency	V/F intermediate frequency ~ max. frequency	0.01	50.00	58
	P111	V/F intermediate voltage	V/F minimum voltage ~ V/F maximum voltage	0.1	Changing	58
	P112	V/F intermediate frequency	V/F minimum frequency ~ V/F base frequency	0.01	2.50	58
	P113	V/F minimum voltage	0~V/F intermediate voltage	0.1	15.0	58
	P114	V/F minimum frequency	0~V/F intermediate frequency	0.01	1.25	59
	P115	Carrier frequency	1.0K-15.0K	0.1	Changing	61
	P116	Automatic carrier line up	Reserved	1	0	*
	P117	Initialization of parameters	8: Initialization of Factory Setting	1	0	62
	P118	Parameter lock	0: Unlock parameters 1: Lock up parameters	1	0	62

Function	Parameters	Name	Setting Range	Minimum Setting increments	Initial value	Refer To Page
Basic functions	P200	Start mode selection	0: regular start 1: restart after inspection	1	0	62
	P201	Stop mode selection	0 : deceleration to a stop 1: coasting	1	0	63
	P202	Starting frequency	0.10~10.00Hz	0.01	0.5	64
	P203	Stopping frequency	0.10~10.00Hz	0.01	0.5	64
	P204	DC injection brake operation current (start)	0~150% rated motor current	1%	100%	65
	P205	DC injection brake operation time (start)	0~25.0S	0.1	0	65
	P206	DC injection brake operation current (stop)	0~150% rated motor current	1%	100%	65
	P207	DC injection brake operation time (stop)	0~25.0S	0.1	0	65
	P208	Torque boost	0~20.0%	1	5%	66
	P209	Rated motor voltage	0~500.0V	0.1	380.0	66
	P210	Rated motor current	0 -- current of system	0.1	Changing	66
	P211	No load current ratio of motor	0-100%	0.1	40%	66
	P212	Rated motor rotation speed	0-6000r/min	1	1420	66
	P213	Number of motor poles	0-20	1	4	66

Chapter 6 Table of Function Parameters

Function	Parameters	Name	Setting Range	Minimum Setting increments	Initial value	Refer To Page
	P214	Rated motor slip	0~10.00Hz	0.01	2.50	67
Basic functions	P215	Rated motor frequency	0-400.00 Hz	0.01	50.00	67
	P216	Resistance of stator	0-100Ω	0.01	0	67
	P217	Resistance of rotor	0-100Ω	0.01	0	68
	P218	Self inductance of rotor	0-1.000H	0.01	0	68
	P219	Mutual inductance of rotor	0-1.000H	0.01	0	68
I/O functions	P300	FIV minimum voltage input	0~FIV maximum voltage	0.1	0	68
	P301	FIV maximum voltage input	FIV minimum voltage~10V	0.1	10.0	68
	P30 2	FIV input filter time	0~25.0S	0.1	1.0	68
	P303	FIC minimum current input	0~FIC maximum current	0.1	0	69
	P304	FIC maximum current input	FIC minimum current input~20mA	0.1	20.0	69
	P305	FIC input filter time	0~25.0S	0.1	1.0	69
	P306	FOV minimum voltage output	0~FOV maximum voltage	0.1	0	70
	P307	FOV maximum voltage output	FOV maximum voltage output~10V	0.1	10.0	70
	P310	Frequency of low analog	0~600.00		0.00	71
	P311	Direction of low analog	0/1	1	0	71
	P312	Frequency of high analog	0~600.00	0.01HZ	50.00	71

Function	Parameters	Name	Setting Range	Minimum Setting increments	Initial value	Refer To Page
I/O functions	P313	Direction of high analog	0/1	1	0	71
	P314	Analog input reverse selection	0/1	1	0	71
	P315	Input terminal FWD (0~32)	0: Invalid 1: Jog 2: Jog Forward 3: Jog reverse 4: Forward/ reverse 5: Run 6: Forward 7: Reverse	1	6	71
	P316	Input terminal REV (0~32)	8: Stop 9: Multi-speed 1 10: Multi-speed 2 11: Multi-speed 3 12: Multi-speed 4 13: Acceleration/	1	7	71
	P317	Input terminal S1 (0~32)	Deceleration terminal 1 14: Acceleration/ Deceleration terminal 2 15: Frequency increase signal (UP) 16: Frequency decrease signal (DOWN)	1	1	71
	P318	Input terminal S2 (0~32)	17: Emergency stop signal	1	18	71
	P319	Input terminal S3 (0~32)	18: Inverter reset signal 19: PID in running 20: PLC in running	1	15	71
	P320	Input terminal S4 (0~32)	21: Start signal for timer 1 22: Start signal for timer 2	1	16	71
	P321 (0~32)	Reserved	23: Counter pulse signal	1	8	71
	P322 (0~32)	Reserved	24: Counter reset signal 25: Memory clear 26: Start winding operation	1	9	71

Chapter 6 Table of Function Parameters

Function	Parameters	Name	Setting Range	Minimum Setting increments	Initial value	Refer To Page
I/O functions	P323	Output terminal M01 (0~32)	0: Invalid 1: In running 2: Frequency reached 3: Alarm 4: Zero speed 5: Frequency 1 reached 6: Frequency 2 reached 7: Accleration 8: Deceleration 9: Indication for under voltage	1	01	80
	P324	Reserved	10: Timer 1 reached 11: Timer 2 reached 12: Indication for completion of phase 13: Indication for completion of procedure 14: PID maximum 15: PID minimum 16: 4-20mA disconnection 17: Overload 18: Over torque 26: Winding operation completed 27: Counter reached 28: Intermediate counter reached 29: Water supply by constant voltage "1" turn on "0" turn off	1	02	80
	P325	Alarm output terminal RA, RB, RC (0~32)	27: Counter reached 28: Intermediate counter reached 29: Water supply by constant voltage "1" turn on "0" turn off	1	03	80
	P326	Output terminal FOV (0~7)	0: Frequency output 1: current output 2: Dc bus voltage 3: Ac voltage 4: Pulse output 1 pulse/Hz	1	0	83
	P327	Reserved	5: 2 pulses/Hz 6: 3 pulses/Hz 7: 6 pulses/Hz	1	1	83

Function	Parameters	Name	Setting Range	Minimum Setting increments	Initial value	Refer To Page
Secondary application	P400	Jog frequency setting	0.00~maximum frequency	0.01	5.00	84
	P401	Acceleration time 2	0~999.9s	0.1S	10.0	85
	P402	Deceleration time 2	0~999.9s	0.1S	10.0	85
	P403	Acceleration time 3	0~999.9s	0.1S	20.0	85
	P404	Deceleration time 3	0~999.9s	0.1S	20.0	85
	P405	Acceleration time 4/Jog acceleration time	0~999.9s	0.1S	2.0	85
	P406	Deceleration time 4/Jog deceleration time	0~999.9s	0.1S	2.0	85
	P407	Designated value of counter	0~999.9s	1	100	85
	P408	Intermediate value of counter	0~999.9s	1	50	85
	P409	Limitation of acceleration torque	0~200%	1%	150%	85
	P410	Limitation of constant speed torque	0~200%	1%	00	86
	P411	Over voltage prevention selection in deceleration	0/1	1	1	86
P412	Automatic Voltage regulation selection	0~2	1	1	87	

Chapter 6 Table of Function Parameters

Function	Parameters	Name	Setting Range	Minimum Setting increments	Initial value	Refer To Page
Secondary application	P413	Automatic-energy-saving selection	0~100%	1%	00	87
	P414	DC Braking voltage	Depends on models	0.1	800.0	87
	P415	Braking duty	40~100%	1	50%	87
	P416	Restart after instant power off	0~1	1	0	89
	P417	Allowable time of power cut	0~10s	1	5.0S	90
	P418	Flank restart Current limited level	0~200%	1	150%	90
	P419	Flank restart time	0~10s	1	50	90
	P420	Fault restart times	0~5s	1	0	90
	P421	Delay time for restart after fault	0~100	2	2	87
	P422	Over torque action	0~3	1	0	91
	P423	Over torque detection level	0~200%	1	00	91
	P424	Over torque detection time	0~20.0S	0.1	00	91
	P425	Reaching Frequency 1	0.00~maximum frequency	0.01	100	92
	P426	Reaching Frequency 2	0.00~maximum frequency	0.01	5.0	92
P427	Timer 1 setting	0~999.9s	0.1	0	92	

Function	Parameters	Name	Setting Range	Minimum Setting increments	Initial value	Refer To Page
Secondary application	P428	Timer 2 setting	0~999.9s	1	0	92
	P429	Constant-speed torque limiting time	0~999.9s	0.1	Changing	93
	P430	Width of arrival of frequency in hysteretic loop	0.00-2.00	0.01	0.50	93
	P431	Jump frequency 1	0.00~maximum frequency	0.01	0	93
	P432	Jump frequency 2	0.00~maximum frequency	0.01	0	93
	P433	Jump frequency hysteresis loop width	0.00-2.00	0.01	0.50	93
	P434	UP/DOWN frequency step	0~10.00Hz	0.01	0.1	
	P435	UP/DOWN frequency Memory options	0: memory 1: No Memory	1	0	
	P500	PLC memory mode	0~1	1	0	94
	P501	PLC starting mode	0~1	1	0	94
	P502	PLC running mode	0: PLC stops after running for one cycle 1: PLC stop mode, it stops after running for one cycle 2: PLC cycle running 3: PLC stop mode, cycle running mode 4: PLC operates at the last frequency after running for one cycle.	1	0	95
P503	Multi-speed 1	0.00~maximum frequency	0.01	10.0	95	

Chapter 6 Table of Function Parameters

Function	Parameters	Name	Setting Range	Minimum Setting increments	Initial value	Refer To Page
Secondary application	P504	Multi-speed 2	0.00~maximum frequency	0.01	15.00	95
	P505	Multi-speed 3	0.00~maximum frequency	0.01	20.00	95
	P506	Multi-speed 4	0.00~maximum frequency	0.01	25.00	96
	P507	Multi-speed 5	0.00~maximum frequency	0.01	30.00	96
	P508	Multi-speed 6	0.00~maximum frequency	0.01	35.00	96
	P509	Multi-speed 7	0.00~maximum frequency	0.01	40.00	96
	P510	Multi-speed 8	0.00~maximum frequency	0.01	45.00	96
	P511	Multi-speed 9	0.00~maximum frequency	0.01	50.00	96
PLC operation	P512	Multi-speed 10	0.00~maximum frequency	0.01	10.00	96
	P513	Multi-speed 11	0.00~maximum frequency	0.01	10.00	96
	P514	Multi-speed 12	0.00~maximum frequency	0.01	10.00	96
	P515	Multi-speed 13	0.00~maximum frequency	0.01	10.00	96
	P516	Multi-speed 14	0.00~maximum frequency	0.01	10.00	96
	P517	Multi-speed 15	0.00~maximum frequency	0.01	10.00	96
	P518	PLC operation time 1	0~999.9s	1S	100	96
	P519	PLC operation time 2	0~999.9s	1S	100	96
	P520	PLC operation time 3	0~999.9s	1S	100	96
	P521	PLC operation time 4	0~999.9s	1S	100	96

Function	Parameters	Name	Setting Range	Minimum Setting increments	Initial value	Refer To Page
	P522	PLC operation time 5	0~999.9s	1S	100	96
PLC operation	P523	PLC operation time 6	0~999.9s	1S	0	96
	P524	PLC operation time 7	0~999.9s	1S	0	96
	P525	PLC operation time 8	0~999.9s	1S	0	96
	P526	PLC operation time 9	0~999.9s	1S	0	96
	P527	PLC operation time 10	0~999.9s	1S	0	96
	P528	PLC operation time 11	0~999.9s	1S	0	96
	P529	PLC operation time 12	0~999.9s	1S	0	97
	P530	PLC operation time 13	0~999.9s	1S	0	97
	P531	PLC operation time 14	0~999.9s	1S	0	97
	P532	PLC operation time 15	0~999.9s	1S	0	97
	P533	PLC operation direction	0~32767	1	0	97
	P600	PID starting mode	0: PID disable 1: PID start 2: PID start by external terminal	1	0	100
	P601	PID operation mode selection	0: Negative feedback mode 1: Positive feedback mode	1	0	101
	P602	PID action set point	0: figure mode (P604) 1: FIV 2: FIC	1	0	101
	P603	PID feedback value selection	0: FIV 1: FIC 2: FIV - FIC 3: FIC - FIV	1	0	101

Chapter 6 Table of Function Parameters

Function	Parameters	Name	Setting Range	Minimum Setting increments	Initial value	Refer To Page
PID operation	P604	PID figure target value setting	0.0~100.0%	0.1%	0.0%	102
	P605	PID upper limit alarm value	0~100.0%	1%	100%	103
	P606	PID lower limit alarm value	0~100.0%	1%	0%	104
	P607	PID proportional band	0.0~200.0%	0.1%	100%	104
	P608	PID integral time	0.0~200.0 S . 0 means closed	0.1s	0.1s	104
	P609	PID differential time	0.00.0~20.00 S . 0 means closed	0.1s	0.0	104
	P610	PID action step-length	0.00~1.00Hz	0.01	0.10Hz	104
	P611	PID standby frequency	0.00~120.0Hz (0.00Hz) 0.00Hz means sleep function is closed	0.01	0.00Hz	105
	P612	PID standby duration	0~200s	1S	10s	105
	P613	PID wake-up value	0~100%	1%	0	105
	P614	PID corresponding value of display	0~10000	1	1000	106
	P615	PID diqit of display	1~5	1	1	106
	P616	PID decimal digits of display	0~4	1	1	106
	P617	PID upper limit frequency	0~max. frequency	0.01	48.00	
	P618	PID lower limit frequency	0~max. frequency	0.01	20.00	

Function	Parameters	Name	Setting Range	Minimum Setting increments	Initial value	Refer To Page
PID operation	P619	PID working mode	0: Always work (PID function open) 1: When feedback reaches upper limit (P605), it will work at Min-frequency. When feedback reaches lower limit(P606), PID will begin to work.	1	0	
RS-485 Communication	P700	Communication speed	0: 4800bps 1: 9600 bps 2: 19200 bps 3: 38400 bps		0	107
	P701	Communication mode	0: 8N1 FOR ASC 1: 8E1 FPR ASC 2: 8O1 FOR ASC 3: 8N1 FOR RTU 4: 8E1 FOR RTU 5: 8O1 FOR RTU			107
	P702	Communication address	0~240	1	0	107
Advanced application	P800	Advanced application parameter lock	0: Locked 1: Unlocked	1	111	113
	P801	System 50Hz/ 60Hz setting	0~50Hz 1~60Hz	1	0	113
	P802	Constant torque or variable torque selction	0: Constant torque 1: Variable torque	1	0/1	114
	P803	Over-voltage protection setting	changing	1	changing	114
	P804	Under-voltage protection setting	changing	1	changing	114
	P805	Over-temperature protection setting	40~120℃	1	85/95℃	114

Chapter 6 Table of Function Parameters

Function	Parameters	Name	Setting Range	Minimum Setting increments	Initial value	Refer To Page
Advanced application	P806	Current display filter time	0~10.0	0.1	2.0	114
	P807	0-10V analogue output low end calibration coefficient	0-65535	1	-	112
	P808	0-10V analog output high end calibration coefficient	0-65535	1	-	112
	P809	0-20mA analogue output low end calibration coefficient	0-65535	1	-	112
	P810	0-20mA analog output high end calibration coefficient	0-65535	1	-	112
	P811	Compensation frequency point for dead time	0.00~maximum frequency	0.01	0.00	
	P812	UP/DOWN frequency Memory options	0: memory 1: No Memory	1	0	

Chapter 7

Detailed Explanations of Functional Parameters

7-1 Parameters for monitoring

Parameters	Name	Setting Range	Description
P000	Main display data selection (Initial value: 00) Setting range (00-32)	00	Displays the set frequency
		01	Displays the inverter output frequency
		02	Displays the inverter output current
		03	Displays the motor speed
		04	Displays the DC bus voltage
		05	Displays the inverter temperature
		09	Displays record of last faults (1)
		10	Displays record of last faults (2)
		11	Displays record of last faults (3)
		12	Displays record of last faults (4)
		13	Displays the recently set frequency of the inverter when the fault occurred
		14	Displays the recently output frequency of the inverter when the fault occurred
		15	Displays the recently output current of the inverter when the fault occurred
		16	Displays the recently output voltage of the inverter when the fault occurred
17	Displays the recently DC bus voltage of the inverter when the fault occurred		
18	Displays the recently temperature of the inverter when the fault occurred		

User can set the initial display of the inverter through parameter P000.

For example, in order to monitor rotation speed through the operation panel, user can set parameter P000 to "03". Initial value of P000 is "00", therefore, if not been changed, inverter will display the set frequency.

P001	Display the set frequency
	It displays the set frequency of inverter.

You can monitor the set frequency of inverter by examining the content of this parameter.

P002	Display the output frequency
	It displays the present output frequency of inverter.

You can monitor the present output frequency of the inverter by examining parameter P002.

P003	Display the output current
	It displays the output current of inverter.

You can monitor the actual output current by examining parameter P003.

P004	Display the motor speed
	It displays the actual rotation speed of motor.

You can monitor the actual rotation speed of motor by examining parameter P004.

P005	Display the DC bus voltage value
	It displays the voltage of DC bus in main circuit of inverter.

You can monitor the actual voltage of DC bus by examining parameter P005.

P006	Display temperature of inverter
	It displays the actual temperature of inverter.

You can monitor the actual temperature of inverter by examining parameter P006, which will help you make judgment on the running condition of inverter.

P010	Alarm record 1
P011	Alarm record 2
P012	Alarm record 3
P013	Alarm record 4
	It records the latest four faults of inverter.







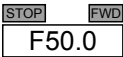

You can check the conditions of latest four faults by examining P010 to P013. These four parameters can help user make judgment on the running condition of inverter and find the cause of fault and eliminate hidden trouble.

P014	Displays the recently set frequency of the inverter when the fault occurred
P015	Displays the recently output frequency of the inverter when the fault occurred
P016	Displays the recently output current of the inverter when the fault occurred
P017	Displays the recently output voltage of the inverter when the fault occurred
P018	Displays the recently DC bus voltage of the inverter when the fault occurred
	They display the detailed status when the latest fault occurs. You can check the actual frequency setting, actual output frequency, actual output voltage, and dc voltage of main circuit in inverter by examining these parameters respectively.

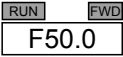
You can check the detailed status when the latest fault occurs by examining the content of P014--P018. You can examine the frequency setting, actual output frequency, and actual output current, actual output voltage, DC bus voltage of main circuit. According to the above data, you can analyze the cause of fault and find a solution quickly, which will help maintenance personnel in repair work.

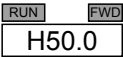
For H2000 series inverter, you can use parameter “F.00” to set the main display data. It’s also possible to monitor the data directly through the parameters “P001~P018”.

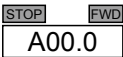
You may monitor the data by pressing the switching key as shown in below table:

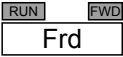
Procedure	Press key	Display	Explanation
1	Turn on power		① Inverter is in standby mode. ② The keypad displays frequency setting. FREE light is on, which means that the keypad is displaying frequency setting
2	Press 		Start inverter ① Inverter is in running and RUN light is on. ② The image displays frequency setting. Forward light is on; inverter is in Forward state.
3	Press  for once		Switch display; stop switching when actual output frequency is displayed. Inverter is in Forward running state. ① The actual output frequency is 50.0Hz.
4	Press  for once		Switch display; stop switching when actual output current is displayed. ① The actual current output is 0A
5	Press  for once		Display running state.

7-2 Basic parameters

P100	Digital frequency setting (Initial value: 0.00Hz)			
	Setting range	0.00-Maximum frequency	Unit	0.01

When P101 is set to 0, inverter works in Digital frequency setting mode. The frequency value is set by P100.

During running, you can change frequency by modifying the content of parameter P100 or by pressing “▲” key or “▼” key to change frequency. If you change frequency by modifying P100, when the inverter stops running or when power is off, the modified content can be remembered.

If you change frequency by pressing “▲” key or “▼” key, when the inverter stops running or power is off, the modified content will not be remembered; instead the original P100 will be remembered. When the inverter is started next time, it will operate at the original value of P100.

P101	Frequency setting selection			Initial value : 0
	Setting range	0-5	Unit	1
	Explanation	0: Digital frequency setting (P100) 1: Analog voltage (0—10VDC) 2: Analog current (0—20mADC) 3. Setting dial (Operation panel) 4. UP/DOWN frequency setting 5: RS485 communication frequency setting		

Frequency setting selection can be used to decide the output frequency of inverter.

0: Digital frequency setting

The output frequency of inverter is decided by P100. Generally speaking, you can change output frequency by pressing the “▲” or “▼” key on Keypad. Refer to P100 for details.

1: Analog voltage mode (0~10VDC)

The output frequency of inverter is decided by external voltage signal (0-10V), which is put into inverter through FIV terminal .

There are two modes of external voltage signal: one is setting signal ranging from 0 to 10V; the other is setting by potentiometer. Refer to the following diagram for connection method.

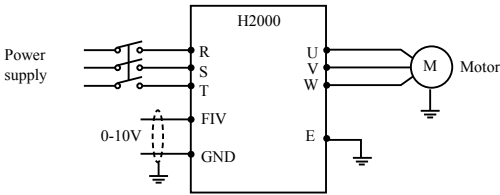

Explanation: control the output frequency through terminal FIV/ FC (0~10V).

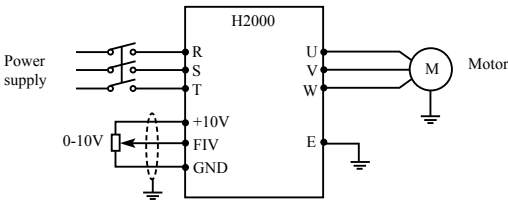

Explanation: control output frequency of inverter by FIV voltage signal sent by external POT (10k Ω)

2: Analog current mode (0~20mA DC)

The output frequency of inverter is decided by external current signal (0-20mA). Control the output frequency of inverter by external terminal FIC.

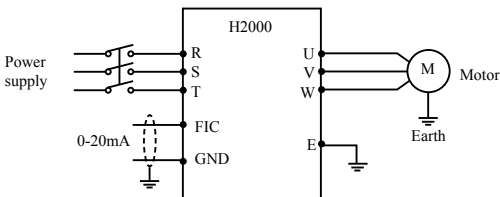

3: Setting dial mode (Operation panel)

You can control the running of H3400 series inverter by the POT knob on Keypad.

Pay attention to the POT knob in Keypad which enables you to switch between monitoring images.



Turn the  change the output frequency

4 UP/DOWN setting mode

The output frequency of inverter is controlled by external UP/DOWN terminals. External terminals can be selected from P315 to P322, been selected one of external terminals as UP/DOWN. When UP is valid, the frequency will go up. When DOWN is valid, the frequency will go down. When UP and DOWN are both valid, the frequency will remain the same.

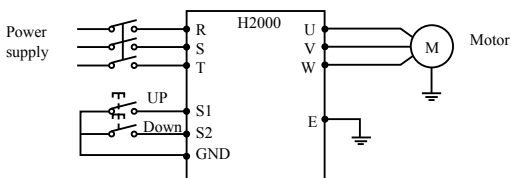

Parameter: P317=15, S1 terminal will be set in UP mode.

P318=16, S2 terminal will be set in DOWN mode.

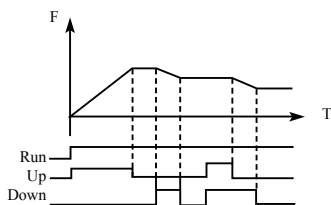

Explanation: when UP is valid (UP is closed), frequency will go up. When DOWN is valid (DOWN is closed), frequency will go down.

P102	Start signal selection		Initial value : 0	
	Setting range	0-2	Unit	1
	Explanation	0: Operation panel (FWD/REV/STOP) 1: I/O terminal 2: Communication (RS485)		

Start signal selection are used to set running signal source.

0: Operation panel (FWD/REV/STOP)

Operation panel gives the running signal. The running of inverter can be controlled by the “**RUN**” key (Forward reverse) key on the operation panel. Press “**STOP/RESET**” key to stop running of inverter.

1: I/O terminal

In the initial setting ,the forward/reverse rotation signals are used as start and stop signals .Turn on either of the forward and reverse rotation signals to start the motor in the corresponding direction.

If both are turned off (or on) during operation , the inverter decelerates to a stop (or Keep the original running condition)

You can make two-wire type or three-wire type control mode by using I/O terminal

① Two-wire type

A two-wire type connection is shown below :

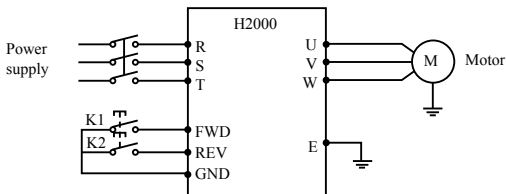

Parameter: P102=1 P315=6 P316=7

Operation Instruction of NT3000 Series Inverter

Actuating explanation:

Input Status		Status of inverter
K1	K2	
ON	OFF	Forward
OFF	OFF	Stop
OFF	ON	Reverse
ON	ON	Keep the original running condition

② Three-wire type

A three-wire type connection is shown below.

The start self-holding selection becomes valid when the STOP signal is turned on. In this case, the forward/reverse rotation signal functions only as a start signal.

If the start signal(S1/S2) is turned on and then off, the start signal is held and makes a start. When changing the direction of rotation, turn S1(S2) on once and then off.

The stop the inverter, turning off the STOP signal once decelerates it to a stop.

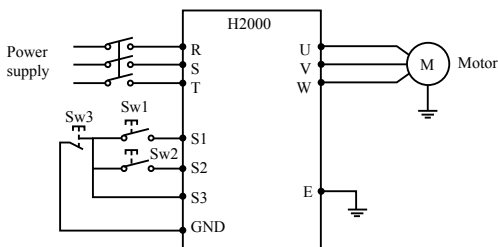

Use S1, S2, or S3 as input terminal for external signal

Parameter: P317=6 S1 is in forward

P318=7 S2 is in reverse

P319=9 S3 is in stop mode

P102=1 external terminal input

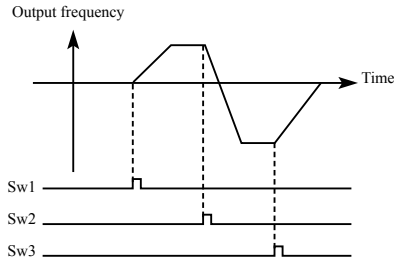

2: RS485 mode

Inverter can receive command and exchange data with computer by serial communication.

P103	"stop" key lock operation selection	nitial value : 1		
	Setting range	0-1	Unit	1
	Explanation	0: "Stop"key lock mode invalid 1: "Stop" key lock mode valid		

The "STOP"key operation of the operation panel can be made invalid to prevent unexpected stop.

Set "0" in P103,then press "ENTER" for 2s to make the "STOP" key operation invalid, and "STOP" key can not stop running of inverter

Set "1" in P103,then press "ENTER" for 2s to make the "STOP" key operation valid, and "STOP" key can stop running of inverter

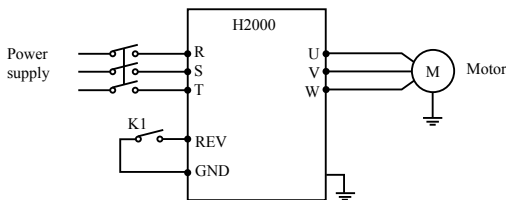

Procedure	Input	Explanation
1	K1 close	Reverse of inverter is started

2	(K1 open) press stop key	Inverter stops
3	K1 open	Running signal is removed
4	K1 close	Reverse of inverter is started

P104	Reverse prevention setting		Initial value : 1	
	Setting range	0-1	Unit	1
	Explanation	0: Reverse prohibited 1: Reverse allowed		

Many devices only allow rotation in single direction. In this case, you can set the machine in single rotation mode by this parameter.

0: Reverse prohibited

Reverse of motor is prohibited. When P104 is set at reverse prohibited, switch between Forward and reverse is invalid.

1: Reverse allowed

Reverse of motor is enabled, switching between forward and reverse is valid.

P105	Max. frequency		Initial value: 50.00	
	Setting range	Min. output frequency ~ 400.00Hz		

The output frequency range of inverter is 0.1~400.00Hz. Therefore, inverter can drive the motor higher than 50/60Hz, which could cause mechanical damage or accident.

This parameter is to limit the inverter output frequency in order to prevent motor operating at too higher speed.

P106	Min. frequency		Initial value : 0.00	
	Setting range	0.00 ~ max. frequency		

This parameter is to set the minimum output frequency of the inverter. If the setting frequency is lower than the Min. frequency, inverter will output on the Min. frequency. In some application, this function could avoid motor overheating due to the low speed operation.

P107	Acc time		Initial value: change
P108	Dec time		Initial value: change
	Setting range	0.1~999.9s	

Acc time refers to the time for inverter to reach the max. frequency from 0.00Hz. Dec time refers to the time for inverter to lower to 0.00Hz from max. frequency.

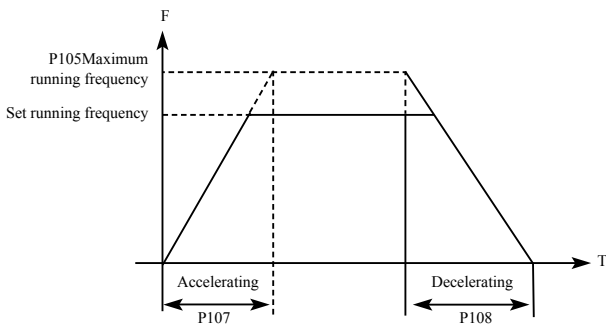

The Default Acc/Dec time is the primary Acc time/ Dec. time. Other Acc time or Dec time can be selected via external terminal.

P109	V/F maximum voltage		Initial value : 380
	Setting range	V/F intermediate voltage~500.00	Unit 0.01
P110	V/F fundamental frequency		Initial value : 50
	Setting range	V/F intermediate frequency ~ max. frequency	Unit 0.01
P111	V/F intermediate voltage		Initial value : change
	Setting range	V/F minimum voltage ~ V/F maximum voltage	Unit 0.1
P112	V/F intermediate frequency		Initial value : 2.5
	Setting range	V/F minimum frequency ~ V/F fundamental frequency	Unit 0.01

P113	V/F minimum voltage		Initial value : 15
	Setting range	0.0 ~ V/F intermediate voltage	Unit 0.1
P114	V/F minimum frequency		Initial value : 1.25
	Setting range	0.0 ~ V/F intermediate frequency	Unit 0.01

Parameters from P109 to P114 determine the V/F curve of inverter. Set corresponding V/F curves according to different loads.

Constant torque curve: application for constant torque load, output voltage and output frequency are in linear relation.

Down (variable) torque curve: application for variable torque load, like fan and pump. Load will increase with the increase of rotation speed.

High start torque curve: application for heavy load and load need high starting torque.

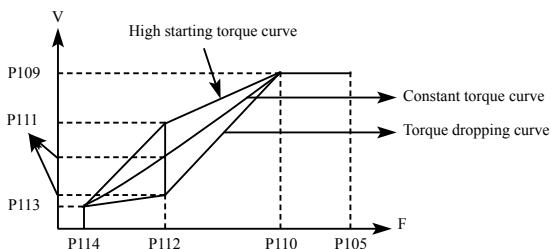

P109: V/F maximum voltage, V/F maximum voltage can be set according to the motor connected. Generally, it will be set at the rated voltage of motor. When motor is very near to inverter, usually within 30m, it should be set at a higher value.

P110: V/F fundamental frequency

V/F fundamental frequency, please set it at the running voltage frequency of motor. Generally, do not change V/F fundamental

frequency setting; or else, it is very likely to damage motor.

P111: V/F intermediate voltage

Set V/F intermediate voltage according to the specific load. Improper setup can cause over current of motor or insufficient torque output, or even cause inverter protection. Increasing the value of P111 can increase output torque and output current. Please monitor output current while changing the value of P111. While changing the value of P111, adjust the value slowly until the necessary output torque is reached. Too higher setting may cause inverter protection or fault.

P112: V/F intermediate frequency

V/F intermediate frequency determines the intermediate point of V/F curve. Improper setup can cause insufficient torque or over current protection of inverter. Generally, do not change the setup value of this parameter while using.

P113: V/F minimum voltage

V/F minimum voltage setup is relevant to start torque to a certain extend. Increasing the value of this parameter properly can increase the torque of starting, it can also cause over current. Generally, it's not necessary to change the value of P113.

P114: V/F minimum frequency

V/F minimum frequency determines the initial point of V/F curve, it is the minimum value in V/F curve.

Please refer to the following table for the specific Default setting of each model:

parameter Model	P107	P108	P111	P115
H2200A00D4K	7	7	15	10
H2200A0D75K	8	8	14	10
H2200A01D5K	9	9	14	9

P115	Carrier frequency	Factory Setting
	Setting range 1-15 unit 1	

Carrier frequency decides the switching frequency of internal power module. The factory setting of inverters with different capacity are different because will affect motor noise, motor heating and disturbance.

Carrier frequency P115	Motor Noise	Motor Heating	Disturbance
Small → Big	Big → Small	Small → Big	Small → Big

Therefore, when the environment demands running without noise, you shall increase the value of P115, the maximum load of inverter will decrease. If motor is far from inverter, you shall lower the value of P115 so as to lower the leakage current between wires and wire to ground. When the environment temperature or motor load is high, you shall lower the value of P115 to reduce the heating of the inverter. Refer to table in P114 for the factory set of P115.

P117	Initialization of parameters	Initial value : 0
	Setting range 0-8	Unit: 1
	Explanation	8: Initialization of parameters

When the parameter setup is not proper or when false running leads to improper setup of parameter, you can set P117 at 08 to restore all parameters to the Factory Setting, and then you can set them again according to actual need.

Attention: when locked up of parameters is valid, that is when P118=1, you cannot carry out initialization of parameters and change them. Please unlock first, and then set these parameters.

P118	Initialization of parameters	Initial value : 0
	Setting range 0-1	Unit: 1
	Explanation	0: Unlocked

1: Locked

You can lock the parameter by P118 to prevent unexpected change of the inverter setup.

When P118 is valid, all the other parameters except P100 (main frequency setting) cannot be changed.

7-3 Parameters of basic applications

P200	Start mode selection		Initial value : 0	
	Setting range	0-1	Unit	1
	Explanation		0: Start at start frequency 1: Tracing start	

There are two start modes for H2000 series inverter. You can choose from the two by setup of parameter P200 and the condition of machinery.

0: Start at start frequency

Most loads do not have special requirement in start. Inverter output from the start frequency.

1: Tracing start

Tracing start is application for start after fault reset or instantaneous power failure. Using tracing start function, inverter can automatically detect the rotation speed and rotation direction of motor, the output the starting frequency and voltage accordingly.

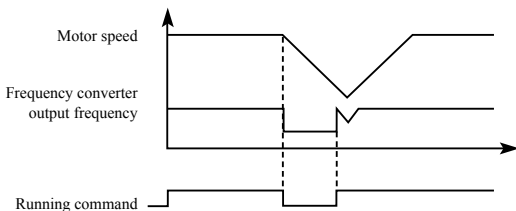

Attention: when inverter starts in tracing start mode, inverter will have speed tracing in the sequence of high to low frequency.

High current is likely in start, it is also possible to cause current. Therefore, you need to have over current level setup (4.09 setup). The specific value depends on the load.

In addition, when the value of 4.09 is too low, it may lead to a long start time. If over current in the speed tracing, inverter will pause the speed tracing.

P201	Stop mode selection		Initial value : 0	
	Setting range	0-1	Unit	1
	Explanation	0: Deceleration to stop 1: Coasting stop		

You can choose a suitable stop mode according to the actual load.

0: Deceleration to stop

Once inverter receives stop command, it will reduce the output frequency according to the deceleration time.

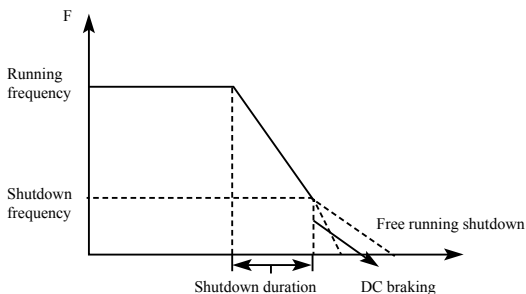

With regard to stop mode after stop frequency is reached, you can choose DC injection brake and other options. If you do not choose DC injection braking, it will stop in coasting stop mode.

1: Coasting stop

When inverter receives stop command, it will stop frequency output and it will have free running with load until it stops.

P202	Start frequency setting		Initial value : 0.5	
	Setting range	0.10-10.00	Unit	0.01

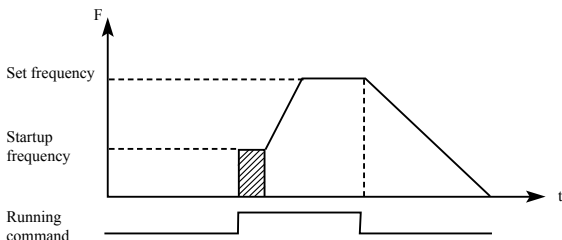

Start frequency is the initial frequency when inverter starts. For device with heavy load or requires large starting torque, increasing start frequency can make start easier. However, if the start frequency is too high, it may cause over current protection.

P203	Stop frequency setting		Initial value : 0.5Hz	
	Setting range	0.10-10.00Hz	Unit	0.01Hz

When inverter receives stop command, it reduce the output frequency until the stop frequency, then it will start coasting stop or DC injection brake stop according to the setting.

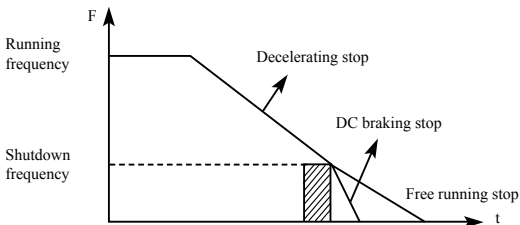

P204	Dc braking current in start		Initial value : 100	
	Setting range	0-150	Unit	1
P205	Dc braking time in start		Initial value : 0	
	Setting range	0-250	Unit	1

Dc braking in start is application for fan in stop mode and moving load. Because before inverter starts, motor is in free running mode

and the rotation direction is unknown. It is easy to cause over current protection in start. Therefore, before start, you shall use DC injection brake to stop the motor in advance.

Dc braking current in start is the ratio of rated current of inverter, adjusting P204 can have different braking torques. While setting value of parameter, you can adjust it from low to high until a sufficient braking torque is reached according to the actual load.

Dc braking time is the period DC injection brake lasts. When it is 0, DC injection brake is invalid.

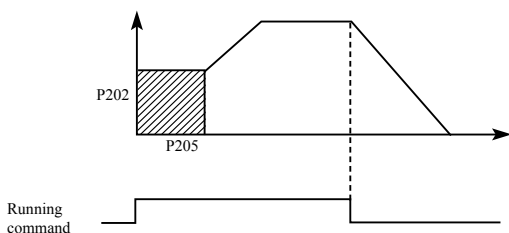

P206	Dc braking current in stop		Initial value : 100	
	Setting range	0-150	Unit	1
P207	Dc braking time in stop		Initial value : 0	
	Setting range	0-250	Unit	1

Dc braking in stop is application for load which has requirement on braking.

Dc braking current in stop is the ratio of rated current of inverter. Adjusting this parameter can have different braking torques.

Dc braking time in stop is the period DC injection brake mode lasts. When it is 0, DC injection brake is invalid.

Refer to the explanations of P203, P204 and P205 for relevant details.

P208	Torque boost		Initial value : 5%	
	Setting range	0.1-20%	Unit	0.1

Adjusting parameter P208 can increase voltage and obtain higher torque.

Attention: Too big setting may cause motor overheating. Increase the setting step by step until you get the requested starting torque.

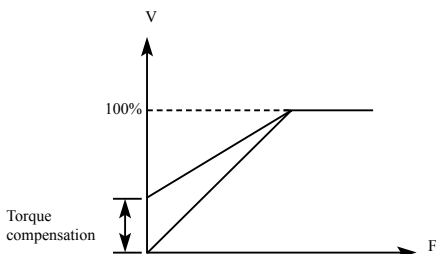

P209	Rated motor voltage		Initial value : 380.00V	
	Setting range	0-500.00	Unit	0.01
P210	Rated Motor current		Initial value : *	
	Setting range		Unit	0.1
P211	No load current ratio of motor		Initial value : 40	
	Setting range	0-100	Unit	1
P212	Rated motor rotation speed		Initial value : 1420	
	Setting range	0-6000	Unit	1
P213	Number of motor poles		Initial value : 4	
	Setting range	0-10	Unit	1
P214	Rated motor slip 2.5		Initial value :	
	Setting range	0-100	Unit	0.1

Please set above parameters according to the motor rating.

P209 Rated voltage motor

Please set rated voltage of motor according to voltage value on motor nameplate.

P210 Rated motor current

Please set rated current of motor according to the current value on nameplate. If the running current exceeds the value of rated current, inverter will trip to protect the motor.

P211 No load current ratio of motor

The value of rated no load current of motor can affect slip compensation. Rated no load current is the percentage of motor current.

P212 Rated motor rotation speed

The value of parameter P112 is the rotation speed at 50Hz. It is related to rotation speed display. Generally, it shall be set according to the value on nameplate.

To display the actual rotation speed of motor, you can set parameter P212 at the actual rotation speed at 50Hz.

P213 Number of motor poles

Set the number of pole pairs of motor by adjusting this parameter according to the value on nameplate

P214 Rated motor slip

When inverter drives motor, slip will increase when load increase. Adjusting P214 can compensation the slip and make motor speed close to the synchronization speed.

P215	Rated motor frequency : 50Hz			Initial value	
	Setting range	0.00-400.00	Unit	0.01	
P216	Resistance of stator 0			Initial value :	
	Setting range	0-100.00	Unit	0.01	
P217	Resistance of rotor : 0			Initial value	
	Setting range	0-100.00	Unit	0.01	
P218	Self inductance of rotor : 0			Initial value	

	Setting range	0-1.000	Unit	0.001
P219	Mutual inductance of rotor : 0			Initial value
	Setting range	0-1.000	Unit	0.001

The above parameters are parameters of motor.

P215 Rated frequency of motor

Please set rated frequency of motor according to motor nameplate.

P216 Resistance of stator

P217 Resistance of rotor

P218 Self inductance of rotor

P219 Mutual inductance of rotor

Set the above parameters according to the actual condition of motor.

7-4 Parameters for input and output application

P300	FIV minimum voltage input		Initial value : 0	
	Setting range	0~FIV maximum voltage input	Unit	0.1
P301	FIV maximum voltage input		Initial value : 10.0	
	Setting range	FIV minimum voltage input~0	Unit	0.1
P302	FIV input filter time		Initial value : 1.0	
	Setting range	0-25.0	Unit	1

P300 FIV minimum voltage input

FIV minimum voltage input value is related to frequency of lowest analogue input. Voltage command below this value is deemed as invalid command.

P301 FIV maximum voltage input

FIV maximum voltage input value is related to frequency of highest analogue input. For voltage higher than this value, the machine will

still operate at this value.

The value of P300 and that of P301 decide the range of input voltage.

P302 Input filter time

Value of input filter time decides the response speed of inverter to analogue change. With the increase of value of P302, the inverter will get slower for responding to analogue change.

P303	FIC minimum current input		Initial value : 0	
	Setting range	0~FIC maximum current input	Unit	0.1
P304	FIC maximum current input		Initial value : 20.0	
	Setting range	FIC minimum current input-20.0	Unit	0.1
P305	FIC input filter time		Initial value : 1.0	
	Setting range	0-25.0	Unit	0.1

P303: FIC minimum current input

FIC minimum current input is related to frequency of lowest analogue input. Inverter will deem current signal below value of P303 as invalid.

P304: FIC maximum current input

FIC maximum current input is related to frequency of highest analogue input. For current command higher than value of P304, inverter will operate at the value.

P305: FIC input filter time

FIC input filter time decides how fast inverter responds to analogue change. With the increase of value of P305, inverter will respond more and more slowly to analogue change. The output of inverter will be relatively stable.

Refer to explanations of P300 to P302 for relevant parameters. If the external input is voltage signal, refer to P300-P302. If the

external input is current signal, refer to P303-P305.

For example, if the output signal of upper computer is 4-20mA, the corresponding frequency shall be within the range of 0–50Hz.

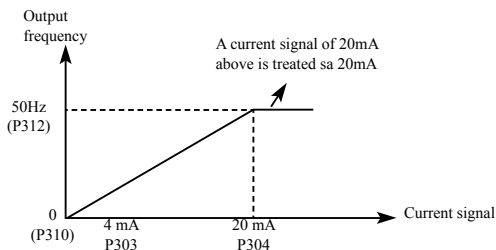

Parameters: P303=4 P304=20 P310= 0 P312= 50

P306	FOV minimum voltage output		Initial value : 0	
	Setting range	0-FOV maximum voltage output	Unit	0.1
P307	FOV maximum voltage output		Initial value : 10.0	
	Setting range	FOV minimum voltage output-10.0	Unit	0.1

The value of P306 and that of P307 decide the range of output voltage of FOV terminal.

P306 FOV minimum voltage output is related to frequency of lowest analogue output.

P307 FOV maximum voltage output is related to frequency of highest analogue output. You can connect voltmeters of various measurement ranges by setting parameter P306 and P307.

For example, use a frequency meter with input voltage of 0-5V and measurement range of 0-50Hz to monitor the output frequency of inverter.

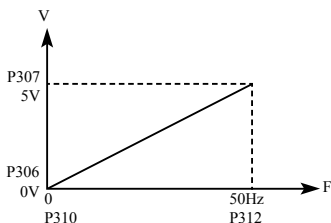

Then you need to set them like the following: P306-P307=5.

P308	FOC minimum current output		Initial value : 0	
	Setting range	0-FOC maximum current output	Unit	0.1
P309	FOC maximum current output		Initial value : 20.0	
	Setting range	FOC minimum current output-20.0	Unit	0.1

P308 and P309 decides the range of output current of FOC terminal. P308 and P309 correspond to frequency of lowest analogue output and frequency of highest analogue output respectively. Refer to explanations of P306 and P307 for relevant parameters.

P310	Frequency of low analog		Initial value : 0.00	
	Setting range	0.0-600.00	Unit	0.01
P311	Direction of of low analog		Initial value : 0	
	Setting range	0-1	Unit	1
	Explanation	0: Positive direction 1: Negative direction		
P312	Frequency of high analog		Initial value : 50	
	Setting range	0.00-600.00	Unit	0.01
P313	Direction of high analog		Initial value : 0	
	Setting range	0-1	Unit	1

	Explanation	0: Positive direction 1: Negative direction		
P314	Analogue reverse options	Initial value : 0		
	Setting range	0-1	Unit	1
	Explanation	0: No reverse at negative bias voltage 1: Reverse allowed at negative bias voltage		

The parameter group of P310-P314 decides the running condition of analogue, including output frequency and direction. According to actual need of user, they can form various control curves.

P310 Frequency of low analog

Frequency of lower analogue decides the output frequency of lowest analogue input, corresponding to analogue minimum voltage (current) input.

P311 Direction of low analog

Direction of lower analogue decides the running condition at low frequency, whether it is Forward or reverse.

P312 Frequency of high analog

Analogue high-end frequency determines high-end output frequency, and is corresponding to analogue maximum voltage (current) input.

P313 Direction of high analog

Analogue high-end direction determines whether the running status of high-end frequency is forward or reverse.

P314 Analog input reverse selection

Analogue reverse selection determines running status of analog negative bias voltage, satisfied curve needed by customer can be constituted by using above parameter.

Example 1: upper computer output 2-10 V signal to control inverter, 50Hz reverse to 50Hz forward running.

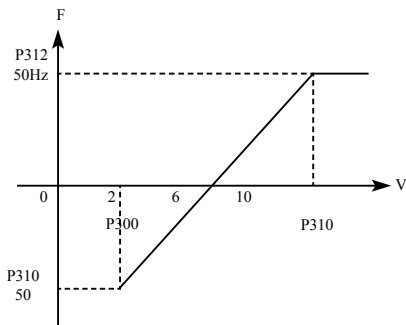

Introduction: P300=2 FIV minimum voltage input: 2V (inverter regards signals below 2V as invalid signals);

P301=10 FIV maximum voltage input: 10V (signals over 10V are regarded and handled as 10V);

P310=50 Analogue low-end frequency: 50Hz;

P311=1 Analogue low-end direction: 1 (reverse);

P312=50 Analogue high-end frequency: 50Hz;

P313=0 Analogue high-end direction: 0 (Forward);

P314=1 Analogue reverse selection: 1 (negative bias voltage can be reversed).

Attention: In various curves, switching instructions of forward and reverse remain effective, when forward and reverse are switched, the curve will be reversed, and the diagram of curve is as follows:

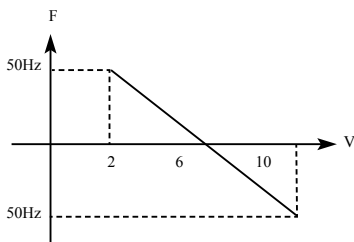

Example 2, upper computer output 4-20mA, and controls running of inverter Output frequency is 100Hz-0Hz

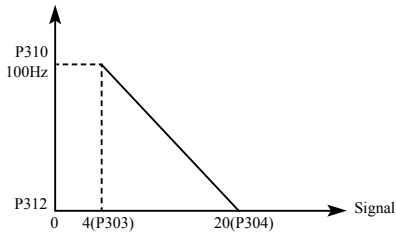

Parameter: P33=4 FIC minimum current input

P304=20 FIC maximum current input

P310=100.00 analogue low-end frequency

P311=0 analogue low-end direction (Forward)

P312=0 analogue high-end frequency

P314=0 analogue high-end direction (Forward)

Special inverted curve can be constituted by using P310-P314.

Introduction: signal input below 4mA is regarded as invalid signal by inverter.

P315	Multifunction input terminal---FWD terminal	Default value 6
P316	Multifunction input terminal---REV terminal	Default value 7
P317	Multifunction input terminal---S1 terminal	Default value 1
P318	Multifunction input terminal---S2 terminal	Default value 18
P319	Multifunction input terminal---S3 terminal	Default value 15
P320	Multifunction input terminal---S4 terminal	Default value 16
P321	Multifunction input terminal---S5 terminal	Default value 8
P322	Multifunction input terminal---S6 terminal	Default value 9
	Range	0-32
	Unit	1

	Settings	<p>0: Invalid 1: Jog 2: Jog Forward 3: Jog reverse 4: Forward/ reverse 5: Running 6: Forward 7: Reverse 8: Stop 9: Multi-speed selection 1 10: Multi-speed selection 2 11: Multi-speed selection 3 12: Multi-speed selection 4 13: Acceleration/ deceleration selection 1 14: Acceleration/ deceleration selection 2 15: Frequency increasing signal Up 16: Frequency decreasing signal Down 17: Coasting stop 18: Fault reset 19: PID function enable 20: PLC function enable 21: Timer 1 start up 22: Timer 2 start up 23: Counter pulse input 24: Counter reset 25: PLC memory clear 26: Winding operation start</p>
--	----------	---

0: Invalid

Set as empty terminal, no function

1: Jog

Set as JOG (inching), usually used in trial running, common inching is operated by 5Hz,

2: Jog Forward

Set as JOG forward.

3: Jog reverse

Set as JOG reverse.

4: Forward/ reverse

Set as forward/ reverse switching, when the terminal is defined to be valid, running status reverse.

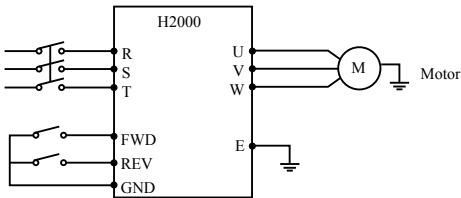

Parameter: P102=1, P315=6, P316=4

Terminal status		Running condition
FWD	REV	
ON	OFF	Forward
ON	ON	Reverse
OFF	OFF	Stop

5: Running

Set terminal as running signal.

6: Forward

When terminal is valid, motor run forward.

7: Reverse

When terminal is valid, motor run reverse.

8: Stop

When terminal is valid, motor run reverse.

9: Multi-speed 1

10: Multi-speed 2

11: Multi-speed 3

12: Multi-speed 4

15-speed can be selected by terminal multi-speed 1, 2, 3 and 4 as below table:

Multi-function terminal				Status and explanation
Multi-speed 1	Multi-speed 2	Multi-speed 3	Multi-speed 4	
0	0	0	0	Primary frequency, Primary frequency is determined by P100 or potentiometer
1	0	0	0	Multi-speed 1 (P503)
0	1	0	0	Multi-speed 2 (P504)
0	0	1	0	Multi-speed 3(P505)
0	0	0	1	Multi-speed 4 (P506)
1	1	0	0	Multi-speed 5 (P507)
1	0	1	0	Multi-speed 6 (P508)
1	0	0	1	Multispeed 7(P509)
0	1	1	0	Multi-speed 8 (P510)
0	1	0	1	Multi-speed 9 (P511)
0	0	1	1	Multi-speed 10 (P512)
1	1	1	0	Multi-speed 11 (P513)
1	1	0	1	Multi-speed 12 (P514)
1	0	1	1	Multi-speed 13 (P515)
0	1	1	1	Multi-speed 14 (P516)
1	1	1	1	Multi-speed 15 (P517)

Remarks: 0: terminal invalid 1: terminal invalid

13: acceleration/ deceleration selection 1

14: acceleration/ deceleration selection 2

4 kinds of acceleration/ deceleration times can be selected by acceleration/ deceleration selection terminal 1and 2.

Multi-function terminal		Acceleration/ deceleration status and result
Acceleration/ deceleration selection 1	Acceleration/ deceleration selection 2	

0	0	Acceleration/ deceleration time 1 (P107, P108)
1	0	Acceleration/ deceleration time 2 (P401, P402)
0	1	Acceleration/ deceleration time 3 (P403, P404)
1	1	Acceleration/ deceleration time 4 (P405, P406)

15. Frequency increasing signal (Up signal)

When this terminal is valid, the frequency increases at a constant speed, until operative frequency is highest.

16. Frequency decreasing signal (Down signal)

When this terminal is valid, the frequency decreases at a constant speed, until operative frequency is lowest.

Attention: Inverter will not memorize the frequency setting changed by “UP” and “DOWN” signal. When power is turned off and reset again, inverter still memorizes the set value in P100.

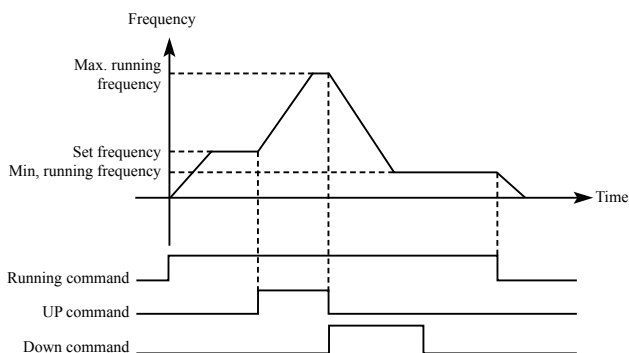

17: Coasting stop

When this terminal is valid, inverter coasting to stop.

18. Fault reset

Reset the inverter when alarm occurs, this terminal function is same

to that of the RESET key on the Keypad.

19. PID function enable

When this contact closes, PID function is enabled. When P601 is set as 2, PID is invalid when this contact is disconnected.

20. PLC function enable

When this contact closes, PLC function starts up, and corresponding PLC function opens.

21. Timer 1 starts up

22. Timer 2 starts up

When this contact closes, timer starts up and begins timing, when the timer reaches set value, corresponding multifunction output contacting action.

23. Counter pulse input

This terminal may accept pulse signals of no more than 250 Hz.

24. Counter resetting

The counted values may be reset and cleared through this terminal.

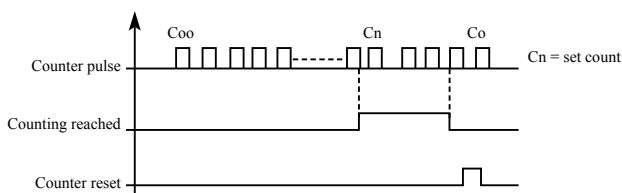

25. PLC memory removal

In the running process of PLC program, owing to fault or stopping, inverter will record status of the program automatically, after the fault is cured and the inverter is switched on again, the inverter will continue running according to the program, when memory removal is valid, program may be reset, and inverter operates from the beginning.

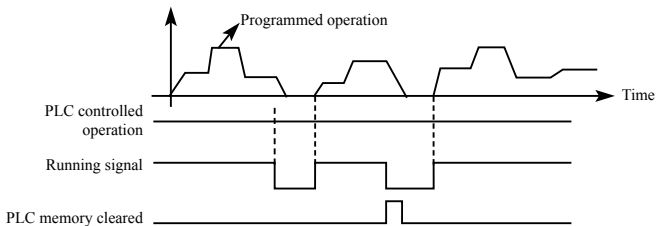

26. Winding function enable

When this signal is valid, winding function is enabled.

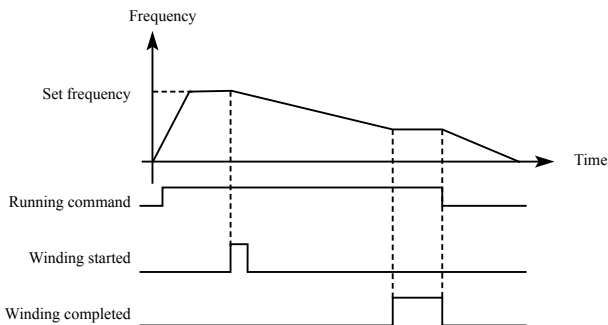

Introduction:

- ① Winding function is activated, and winding begins;
- ② Winding operation complete, inverter output according to the frequency that winding is completed. The multifunction terminal output the winding complete signal;
- ③ Inverter stops, the winding complete signal reset.

P323	Output terminal M01	Default value 01
P324	Output terminal M02	Default value 02
P325	Output terminal YA, YB, YC	Default value 03
	Range	0-32
	Unit	1

	Setting	<p>0: Invalid 1: In running 2: Frequency reached 3: In fault 4: Zero-speed 5: Frequency 1 reached 6: Frequency 2 reached 7: Accelerating 8: Decelerating 9: Under voltage 10: Timer 1 reached 11: Timer 2 reached 12: Indication for completion of phase 13: Indication for completion of procedure 14: PID upper limit 15: PID lower limit 16: 4-20mA cable open 17: Overload 18: Over torque 26: Winding function complete 27: Counter reached 28: Intermediate counter reached</p>
--	---------	--

0: Invalid

Set as invalid terminal, prevent false operation.

1. In running

Terminal is defined to be in running, when inverter is output, this terminal is ON.

2. Frequency reached

When frequency arrives at setting value, this contact is ON

3. In fault

When inverter detects abnormal existing, this contact is ON.

4. Zero-speed

When frequency output by inverter is less than start-up frequency, this contact is ON.

5. Frequency 1 reached

6. frequency 2 reached

When frequency arrives at setting value, this contact is ON.

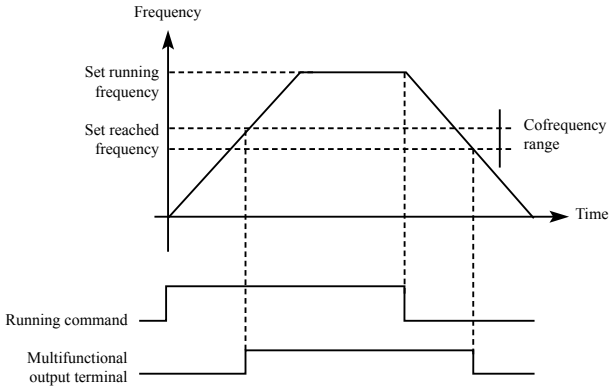

7: Accelerating

When inverter is in the status of accelerating, this contact is ON.

8: Decelerating

When inverter is in the status of decelerating, this contact is ON.

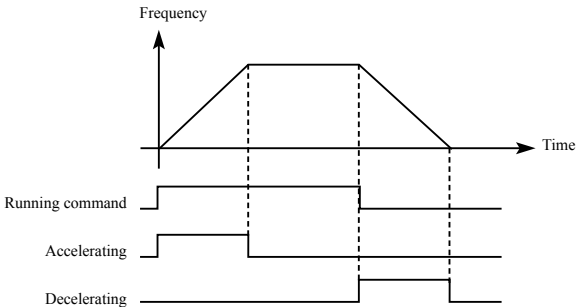

9. Under voltage alarming

When inverter detects that DC bus voltage is lower than setting value, this contact is ON and alarm. Under voltage alarming setting value can be changed through advanced application parameter group.

10: Timer 1 reached

11: Timer 2 reached

When inverter arrives at setting value, this contact is ON, when timer start-up signal is removed, this contact is reset.

12: Stage completion indication

In the PLC operation mode, inverter output this pulse signal when inverter finished a section of program.

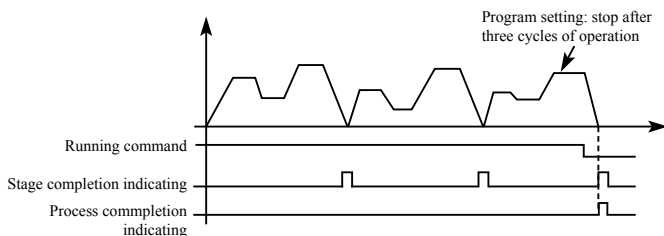

13. Process completion indication

In the PLC operation mode, inverter output this pulse signal when inverter finished the entire program.

14. PID upper limit

When PID feedback quantity exceeds setting value of upper limit, this contact is ON.

15: PID lower limit

When PID feedback quantity is lower than setting value, this contact is ON.

16: 4-20mA cable open

When FIC input signal is disconnected, this contact is ON and alarms.

17: Overload detection

When inverter detects that motor overloads, this contact is ON.

18: Over torque detection

When inverter detects over torque, this contact is ON.

26: Winding function complete

When winding function is complete, this contact is ON. When inverter stops, this contact is reset.

27: Set counter reached

When inverter implements external counter, and when count value arrives at setting value (P425), this contact is ON.

28: Middle counter reached

When inverter counts, if count value arrives at setting value (P426), this contact is ON.

P326	Output terminal FOV		Default value 0	
	Setting range	0-7	Unit	1
P327	Output terminal FOC value 1			Default
	Setting	0: Output frequency 1: Output current 2: Direct voltage 3: Alternating voltage		

P326 output terminal FOV

FOV terminal may output 0-10V voltage, output may be setting in range of 0-10V through P306 and P307 and being corresponding to output frequency, output current, direct voltage, alternating voltage and so on.

P327 output terminal FOC

FOC terminal may output 0-20m current, output range may be setting by P308 and P309 and being corresponding to output frequency, output current, direct voltage, alternating voltage and so on.

0: Output frequency:

Current (voltage) output is corresponding to Min. output frequency~max. frequency.

1: Output current

Current (voltage) output is corresponding to 0~2×inverter rated current.

2: Direct voltage

Current (voltage) output is corresponding to 0~1000V.

3: Alternating voltage

Current (voltage) output is corresponding to 0~510V.

For example: select a frequency meter of 0~5V, supervise output frequency, setting the Min. output frequency of inverter as 0.00Hz, the highest output frequency is 80Hz.

Then:

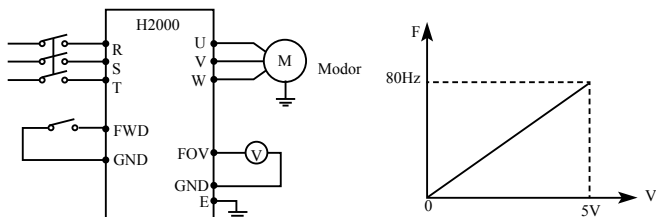

Parameter: P105=80.00 Max. frequency

P106=0.00 Min. output frequency

P306=0.00 FOV minimum voltage output

P307=5.00 FOV maximum voltage output

7-5 Secondary application group

P400	Jog frequency setting		Default value 5.00	
	Range	0.00---max. frequency	Unit	0.01

Jog frequency setting is usually applied to trial run. This function can only be through external terminal.

When JOG function is achieved, other instruction is invalid. When JOG signal is open, inverter decelerate to stop, JOG acceleration/ deceleration time is set in the 4th acceleration/ deceleration parameter.

Control priority level:

Jog→ external multi-speed→PLC operation means→ PID means→ triangle wave (traverse function) → winding→ frequency conversion setting means.

P401	Acceleration time 2	Default value 10.0
P402	Decelerate time 2	Default value 10.0
P403	Acceleration time 3	Default value 20.0
P404	Decelerate time 3	Default value 20.0
P405	Acceleration time 4	Default value 2.0
P406	Decelerate time 4	Default value 2.0
	Range	0-999.9s
	Unit	0.1

H2000 series inverters can set 4 acceleration/ deceleration time. For normal operation, the default selection is the acceleration/ deceleration time 1. For JOG operation, the default selection is acceleration/ deceleration time 4.

P407	Setting value of counter	Default value 100
P408	Middle value of counter	Default value 50
	Range	0-999.9s
	unit	1

H2000 series inverter designs 2 groups of counters, pulse signal less than 250Hz can be accepted through multi-function terminal, when count value reaches setting value, corresponding multi-function output terminal is ON, input terminal of counter resets signal through counter, counter resets and begins counting again.

P409	Acceleration torque limiting level	Default value 150
	Range	0-200
	Unit	1

Parameter P409 is the torque limit level during acceleration. When output current reaches the setting value, inverter will stop accelerating, and when current is below the set value, inverter resume the accelerating.

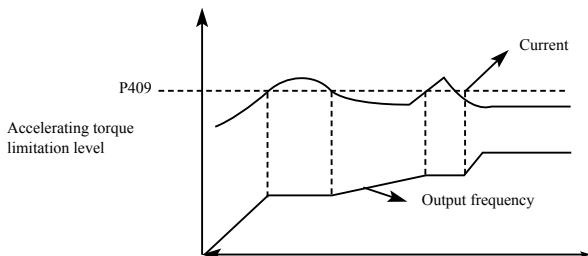

100% current is the rated current of inverter, when P409 is set to be 0, then accelerating torque limit is invalid, and it does not have protecting function.

P410	Constant-speed torque limiting level		Default value 00	
	Range	0-200	Unit	1

Parameter P409 is the torque limit level during constant speed. When output current reaches the setting value, inverter automatically reduce the output frequency in order to reduce the load. When the output current drops, inverter increase output frequency to the setting (100% current is rated current of inverter).

When P410 is set to be 0, constant-speed torque limiting level is invalid and cannot protect.

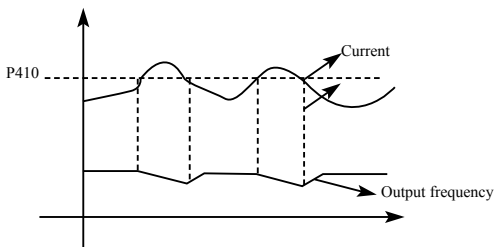

P411	Deceleration over-voltage prevention selection		Default value 1	
	Range	0-1	Unit	
	Settings	0:Invalid 1:Valid		

0: Invalid

During deceleration, the DC-bus voltage may increase, when over-voltage prevention selection is invalid, inverter may trip for over voltage.

1: Valid

During deceleration, when DC-bus voltage reaches the setting value, inverter will stop the deceleration procedure. When DC-bus voltage returns to allowable value, inverter will resume the deceleration.

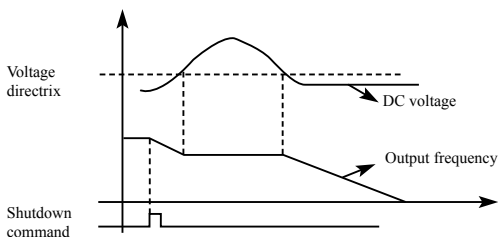

P412	Automatic voltage regulation selection		Default value 1	
	Range	0-2	Unit	1
	Settings	0: Invalid 1: Valid 2: Invalid when decelerating		

If the input voltage is not stable, temperature of the machinery will increase, insulation may be damaged, and output torque will be instable.

0: Invalid

Select automatic voltage regulation to be invalid, inverter output voltage fluctuates.

1: Automatic voltage regulation is valid.

Automatic voltage regulation function is selected, and under the condition that input electric source is instable, inverter output stable voltage automatically.

2: Invalid when decelerating: when this function is selected, braking function of inverter can be strengthened.

P413	Automatic energy-saving selection		Default value 0.0	
	Range	0-100	Unit	1
P414	DC Braking voltage Default value:650V for H3400 / 375V for H3200			
	Range	H3400 series: 650V~800V H3200 series: 360V~400V	Unit	1
P415	Braking duty		Default value: 50	
	Range	40-100	Unit	1

P413 Automatic energy-saving selection

In constant-speed running of automatic energy-saving selection, best voltage value may be calculated by loading condition and provided to load, in order to achieve best energy-saving.

Attention: for running that load changes frequently or is almost at full load, this function is not suitable.

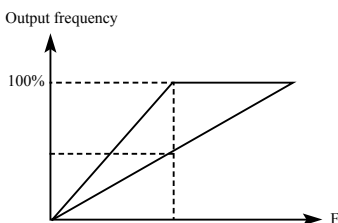

P414 and P415 are only useful for inverter with built-in braking units, and are invalid for inverter with external braking units.

The two parameters adjust internal DC braking voltage level and braking ratio of inverter.

F.414 DC Braking voltage

When inverter DC high voltage is higher than set value of P414, built-in braking unit is ON. Energy is released through braking resistor, then DC voltage falls back, when DC voltage falls to a certain value, built-in braking unit stop.

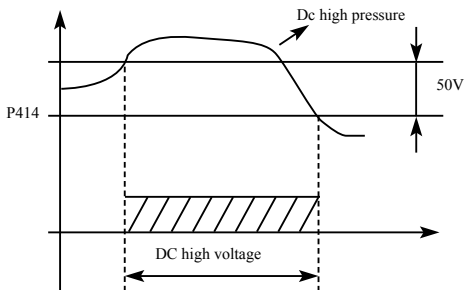

If P414 is too high, DC voltage may be too high and may cause inverter protection.

If P414 is too low, braking resistor maybe too hot.

P415 Braking duty

This parameter decides the working duty of the braking resistor.

Higher duty needs high power of braking resistor.

P416	Restart after instant power off		Default value 0	
	Range	0-1	Unit	1
	Settings	0: Invalid: no restart after instant power failure 1: Valid: frequency tracing start-up		

0: Invalid

Inverter clears the running command after power failure. After power is recovered, inverter will not start automatically.

1: Frequency tracing enable

When power is shut-off in short time, inverter keeps the running command as effective. When power is recovered in time, inverter will tracing the motor speed and resume output.

Attention: when instant power failure restarting is enabled, inverter may start the motor automatically. Please take care of the safety when use this function.

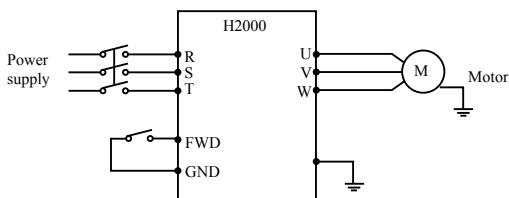

Example:

Use K1 (FWD), control running of inverter.

K1 closes, frequency conversion operates, when K1 is cut off, inverter stops. When power is shut off and K1 remains closed, if power is on, inverter starts up suddenly and it may be very dangerous. Please use other control methods, such as three-wire system connection method.

P417	Allowable time of power off	Default value 5.0		
	Range	0-10.0	unit	0.1

P417 sets allowable time of power failure, if time of power failure exceeds set value, power failure restart is invalid.

P418	Flank restart current limiting level	Default value 150		
	Range	0-200	Unit	1

When inverter implements flying restart, inverter tracing downwards from setting frequency by highest speed, output current of inverter increases relatively rapid and may exceeds protection unit setting by inverter, at this time, inverter stops tracing, and output current of inverter falls back to common, inverter continues tracing, setting value 100% of this parameter is rated current of inverter, and protection unit when inverter searching may be set through P418.

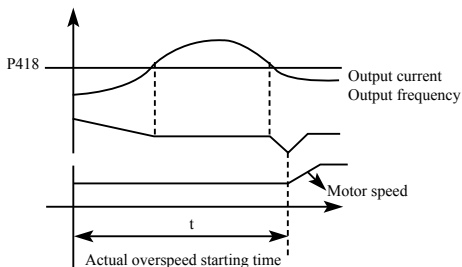

P419	Flank restart time		Default value 5	
	Range	0-10	Unit	

When inverter enabled the flying restart function, inverter tracing motor speed downwards within the setting time. If it is not completed within setting time, inverter protects.

In above example, when t value $>$ P419 setting value, inverter protects.

P420	Fault restart times		Default value 0	
	Range	0-5	Unit	1
P421	Delay time for restart after fault		Default value 2	
	Range	0-100	Unit	1

After alarm (such as current, over-voltage and so on) occurs, inverter resets automatically (valid when non-zero as set by P420), after the period of time set by P421, inverter starts up according to setting start-up means (P200).

After start-up, if no alarm happens within 60 seconds, inverter resets P420 automatically, after start-up,

If alarm happens again within 60 seconds, inverter records number of alarms, and when number of alarms reaches set value of P420, inverter stops output.

Attention: If P420=0, fault restart is invalid.

When fault restart function is valid, motor may start suddenly, so when this function is used, please pay attention to safety.

P422	Over torque action		Default 0	
	Range	0-3	unit	1
	Settings	0: Inverter start detecting over torque only in constant speed, inverter continues operation during over torque 1: Inverter start detecting over torque only in constant speed, inverter stop during over torque 2: Inverter always detecting over torque, inverter continues operation during over torque 3: Inverter always detecting over torque, inverter stop during over torque		

P423	Over torque detection level		Default 0	
	Range	0-200%	Minimum	1
P424	Over torque detection time		Default 0	
	Range	0-200s	Minimum	1

When output current of inverter exceeds setting value of P423, inverter start calculate the over torque time. When the duration exceeds half of setting value of P424, inverter output pre-alarm signal. Inverter continues output until the over torque time exceeds P424 setting, and then inverter protects and output alarm signal.

If P423=0. over torque detection is invalid, and 100% is inverter rated current.

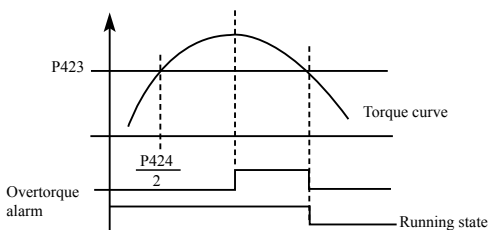

P425	Reaching frequency 1			Default value 100	
	Range	0-Max. frequency	Unit	0.1	
P426	Reaching frequency 2			Default value 5.0	
	Range	0- Max. frequency	Unit	0.1	

H2000A series sets two groups of frequencies arrive, when output frequency arrive the setting value of P425 and P426, corresponding multi-function output terminal is ON. Frequency arrive width is of a hysteresis loop, which is set by P430.

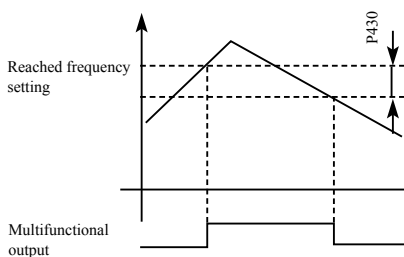

P427	No. 1 timer			Default value 0	
	Range	0.0-999.9s	Unit	0.1	
P428	No. 2 timer			Default value 0	
	Range	0.0-999.9s	Unit	0.1	

H2000 series have two timers, when time of the timers reaches setting value (set by P427 and P428), corresponding multi-function terminal is ON.

Timer start is controlled by external multi-function input terminal.

Some simple program may be made by using these two timers.

P429	Constant-speed torque limiting time			Default value 0.50	
	Range	0-999.9s	unit	0.1	

P430	Width of arrive of frequency in hqsteretic loop Default value 0.50			
	Range	0.00-2.00	unit	0.01

This parameter sets frequency reached width, for details, refer to P425-F426 introductions.

P431	Jump Frequency 1		Default value 0	
	Range	0.00-frequency upper limit	unit	0.01
P432	Jump Frequency 2		Default value 0	
	Range	0.00-frequency upper limit	unit	0.01
P433	Jump frequency hysteresis loop width		Default value 0.50	
	Range	0.00-2.00	unit	0.01

If machine resonance occurred at a certain frequency, we can use the frequency jump function to skip the resonance point. H2000A support 2 jump frequencies by parameter P431 and P432. Frequency jump hysteresis loop width can be set through P433 as below:

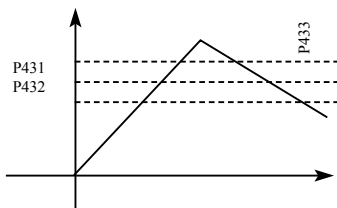

7.5 Special operation (PLC Control)

P500	PLC memory mode		Initial value: 0	
Range	0-1	Unit	1	
	Content:	0: Do not remember 1: Remember		

0: Do not remember

In the operational process of PLC program, P500 will choose not to remember. When machinery stops because of fault or other reasons, inverter will not remember status before the stopping. After restart, running begins from initial state.

1: Remember

In the running of PLC program, P500 will select to remember. When it stops because of fault or other reasons, inverter will remember status before stopping. After restart, inverter will continue operating according to program. Attention: power cannot be cut off.

Stop, power cut and power on, inverter will not remember status before power cut off. After restarting, inverter will run according to initial state of program.

P501	PLC start mode		Initial value: 0	
	Range	0-1	Unit	1
	Content:	0: Invalid (PLC can not start) 1: Valid (PLC start)		

P501 determines PLC start mode of inverter.

P501=0, means PLC is invalid. The inverter is operated by common mode.

When P501=1, PLC will start. The inverter select PLC program to run.

Under the status of PLC start, when various running orders and programs, inverter will choose the highest level to run according to priority level.

Precedence level	Priority level	Item
High→ low	1	Jog
	2	External multi-speed
	3	Internal multi-speed
	4	PID

High→ low	5	Triangular wave
	6	Winding
	7	Inverter setting mode

P502	PLC running mode		Initial value:0	
	Range	0-4	Unit	1
	Content:	0: PLC stop running after a week 1: PLC pause mode, stop running after a week 2: PLC cycle running 3: Cycle running of PLC pause mode 4: After running for a week, PLC continues running by the end of running frequency		

PLC running mode determines running status of internal multi-speed, either running one circle or cycle running. P502 is only valid when PLC starts up.

PLC pause mode means that when completing every speed in the running process of internal multi-speed, the speed will be down, stop, and accelerate to the next speed. The illustration is as below:

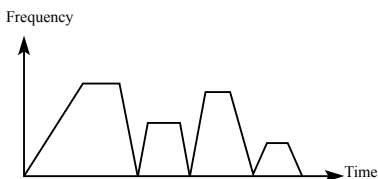

Users may select proper running mode according to actual conditions.

P503	Multi-speed 1	Initial value: 10.0
P504	Multi-speed 2	Initial value: 15.0
P505	Multi-speed 3	Initial value: 20.0
P506	Multi-speed 4	Initial value: 25.0

P507	Multi-speed 5	Initial value: 30.0		
P508	Multi-speed 6	Initial value: 35.0		
P509	Multi-speed 7	Initial value: 40.0		
P510	Multi-speed 8	Initial value: 45.0		
P511	Multi-speed 9	Initial value: 50.0		
P512	Multi-speed 10	Initial value: 10.0		
P513	Multi-speed 11	Initial value: 10.0		
P514	Multi-speed 12	Initial value: 10.0		
P515	Multi-speed 13	Initial value: 10.0		
P516	Multi-speed 14	Initial value: 10.0		
P517	Multi-speed 15	Initial value: 10.0		
	Setting range	0.00 ----- Max. frequency	Unit	0.01

P503 ----- P517 are set of 15 speed of rated frequency in the running. Regarding relationship multi speed and external terminal please refer to rated instruction 1,2,3,4 of multifunctional terminal.

P518	PLC operation time 1	Initial value: 100		
P519	PLC operation time 2	Initial value: 100		
P520	PLC operation time 3	Initial value: 100		
P521	PLC operation time 4	Initial value: 100		
P522	PLC operation time 5	Initial value: 100		
P523	PLC operation time 6	Initial value: 0		
P524	PLC operation time 7	Initial value: 0		
P525	PLC operation time 8	Initial value: 0		
P526	PLC operation time 9	Initial value: 0		
P527	PLC operation time 10	Initial value: 0		
P528	PLC operation time 11	Initial value: 0		

P529	PLC operation time 12		Initial value: 0	
P530	PLC operation time 13		Initial value: 0	
P531	PLC operation time 14		Initial value: 0	
P532	PLC operation time 15		Initial value: 0	
	Setting range	0-999.9s	Unit	1

PLC operation time determines internal controlling varying rated running duration for each segment, and the running duration for each segment is corresponding to its rate.

P533	PLC operation time 15		Initial value: 0	
	Setting range	0-32767	Unit	1

P533 setting running direction of each segment

Method of setting running direction:

The way of setting running direction: by means of 16-bit binary system, and then transfer to decimal system value; every bit decides the corresponding running direction: 0 is running forward and 1 is running backward, and this parameter is only valid when the PLC is on.

For example: there is a five-segment rate, the circling running is required as follow:

Items	Output frequency	Running direction	Running duration
Dominant frequency	Potentiometer is adjustable	Forward	
Segment 1	20.0	Reverse	20
Segment 2	60.0	Forward	25
Segment 3	40.0	Reverse	30
Segment 4	15.0	Forward	20

Two buttons, one is for running, the other one is for ceasing; the main frequency requires adjustable potentiometer.

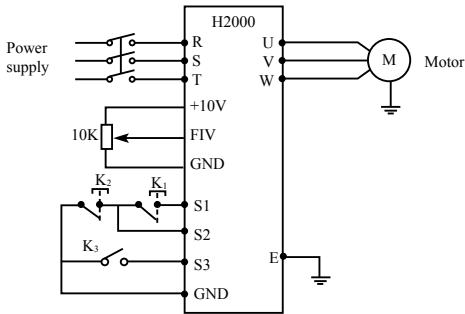

(1) Connection illustration

(2) Parameter setting

PLC operation direction setting: (P533 setting)

Rate of segment 1	Rate of segment 2	Rate of segment 3	Rate of segment 4	Dominant frequency	
4	3	2	1	0	→ position (bit)
0	1	0	1	0	→ run direction <0 is forward, 1 is Reverse
0×24	1×23	0×22	1×21	0×20	→ transfer to decimal system

The binary system number 01010 is transferred to decimal system number: $1 \times 2^1 + 1 \times 2^3 + 8 = 10$

Define to: P533=10

The parameter defines to:

- P101=3 (Keyboard potentiometer setting mode: dominant frequency is controlled by potentiometer)
- P102=2 (Running setting option: Multifunction end input)
- P105=60 (The max. frequency is 60HZ)
- P107=10 P108=10 (acceleration/deceleration time 10S)
- P314=6 (S1 end is running forward)
- P318=8 (S2 end is ceasing)

P319=20	S3 end is PLC starting to running
P500=1	PLC programming memory
P501=1	PLC is on
P502=0	PLC operation one circle and then ceasing
P503=1	Segment 1 rated 20Hz
P504=60	Segment 1 rated 60Hz
P505=40	Segment 1 rated 40Hz
P506=15	Segment 1 rated 15Hz
P518=10	Segment 1 rated running duration is 10s
P519=20	Segment 1 rated running duration is 20s
P520=25	Segment 1 rated running duration is 25s
P521=30	Segment 1 rated running duration is 30s

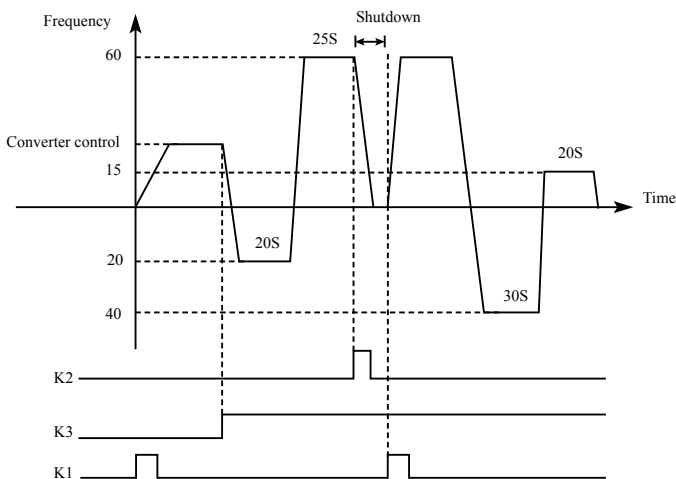

- Action instruction: ① Press K1 to startup the inverter and the potentiometer will set output frequency.
- ② Press K3, PLC to startup, and from the segment 1 PLC program running one circle and then ceasing

- ③ If the program is running, press K3, or if there is a fault, and the inverter is ceasing, when the fault is solved, press K1 and the inverter will running forward as the program.
- ④ If P500 is 1 and the program is not memory, so the running will start from the very beginning.

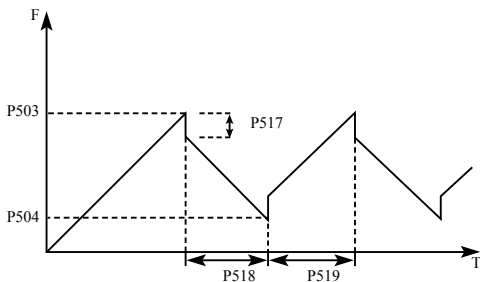

7-7 Special operation (PID Control)

The inverter can be used to exercise process control, e.g. flow rate, air volume or pressure.

The terminal FIV/FIC input signal or parameter setting is used as a set point and the terminal FIV/FIC input signal also can be used as a feedback value to constitute a feedback system for PID control.

P600	PID starting mode		Initial value: 0	
	Setting range	0-1	Unit	1
	Content:	0: PID disable 1: PID start 2: PID start by external terminal		

0: PID disable

PID can not use.

1: PID start

PID is working despite the external signal input, and keeps being valid without external input.

2: PID starts up on condition; PID will start when certain external input is ON.

P601	PID operation mode selection		Initial value: 0	
	Setting range	0-1	Unit	1
	Content:	0: Negative feedback mode 1: Positive feedback mode		

0: Negative feedback mode

If feedback value(P603)>setting value(P602), inverter decrease output frequency

If feedback value(P603)<setting value(P602), inverter increase output frequency

1: Positive feedback mode

If feedback value(P603)>setting value(P602), inverter decrease output frequency

If feedback value(P603)<setting value(P602), inverter increase output frequency

P602	PID action set point		Initial value:0	
	Setting range	0-2	Unit	1
	Content:	0: figure mode (P604) 1: FIV 2: FIC		

0: Select figure mode as the set point (P604)

Set the set value (P604) from the operation panel or parameter unit.

1: FIV

Terminal FIV input is the set point (0—10DCV).

2: FIC.

Terminal FIC input is the set point (0—20mA).

P603	PID feedback value selection		Initial value:0	
	Setting range	0-3	Unit	1
	Content:	0: FIV 1: FIC 2: FIV-FIC		

3: FIC-FIV

Notes:P603 parameter setting: Select PID feedback channel

0:FIV

Input the signal from the detector (measured value signal (0—10DCV))

1:FIC

Input the signal from the detector (measured value signal (0—20mA))

2:FIV-FIC

Input the signal from the detector (measured value signal)

3: FIC-FIV

Input the signal from the detector (measured value signal)

P604	PID figure target value setting		Initial value:0	
	Setting range	0.0-100%	Unit	0.01
	Content:	Select FIV as feedback value		

100% setting is corresponding to analog input 10V voltage.

PID closed-loop control is widely used to control the process such as pressure and temperature.

Feedback signal is given from temperature transmitter or pressure transmitter. In case of PID control, the channel of feedback signal input is of analog signal (4 – 20mA or 0 – 10V). There are two channels available for setting.

Block diagram of PID control:

General regulation method for PID control:

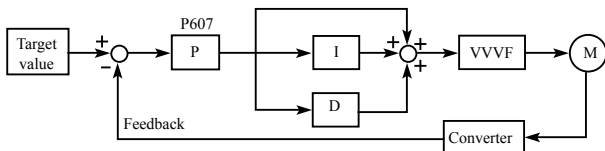

- (1) Select sensor/transmitter correctly, for which the standard signal of 4 – 20mA or 0 – 10V shall be selected as output specification.
- (2) Set PID action set point correctly.
- (3) Increase proportional constant (P), in case of non-oscillating output.
- (4) Decrease integration time (Ti), in case of non-oscillating output.
- (5) Increase differential (Td), in case of non-oscillating output.

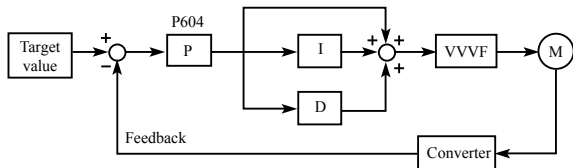
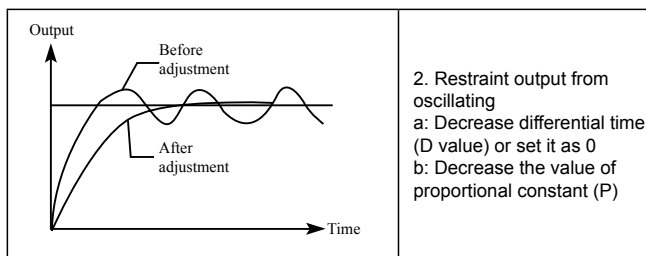
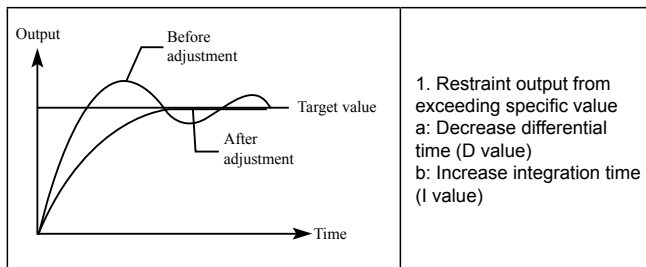

P605	PID upper limit alarm value		Initial value :100	
	Setting range	0.0 – 100%	Unit	0.1

Set the upper limit value. If the feedback value exceeds the setting,

the alarm signal is output. The maximum input (20mA/10V) of the measured value (Terminal FIVFIC) is equivalent to 100%.

P606	PID lower limit alarm value		Initial value : 0	
	Setting range	0.0 – 100%	Unit	0.1

Set the lower limit value. If the feedback value falls below the setting range , the alarm signal is output. The maximum input (20mA/10V) of the measured value (Terminal FIVFIC) is equivalent to 100%.

P607	PID proportional band		Initial value :100%	
	Setting range	0.0 – 200%	Unit	0.1

If the proportional band is narrow (parameter setting is small), the manipulated variable varies greatly with a slight change of the measured value. Hence, as the proportional band narrows, the response sensitivity (gain) improves but the stability deteriorates, e.g.hunting occurs.

P608	PID integral time		Initial value : 0.3s	
	Setting range	0.0 – 200.0S	Unit	0.1

For deviation step input, time(Ti) required for only the integral (I) action to provide the same manipulated variable as that for the proportional (P) action. As the integral time decreases, the set point is reached earlier but hunting occurs more easily.

P609	PID differential time		nitial value :0	
	Setting range	0.00 – 20.0	Unit	0.01

For deviation lamp input, time (Td) required for providing only the manipulated variable for the proportional (P) action. As the differential time increases, greater response is made to a deviation change.

P610	PID action step-length		Initial value : 0.10	
	Setting range	0.00 – 1.00HZ	Unit	0.01

PID is figured out once every 10ms. Frequency increment will be

figured out (Δ FHz) every time. While frequency increment is more than value of P610 in maximum of frequency increment, P610 will work.

P611	PID standby frequency		Initial value : 0.00	
	Setting range	0.00 – 120.00HZ	Unit	0.01
P612	PID standby duration		Initial value : 10.0	
	Setting range	0.0 – 200.0	Unit	0.1
P613	PID wake-up value value: 0.0%		Initial	
	Setting range	0.0 – 100%		

P611 PID standby frequency.

P611 must reach minimum frequency in PID standby. When running frequency is less than value of P610 standby duration will begin counting.

P612 PID standby duration.

When running duration of inverter is more than standby frequency the value (standby duration) of P612, the inverter will be standby. Then stop output, and disconnect with PID, but monitor the feedback of P613 PID.

P613: PID wake-up value.

When the inverter detects that feedback value less than wake-up value (P613), PID function will be taken action, and then inverter will start.

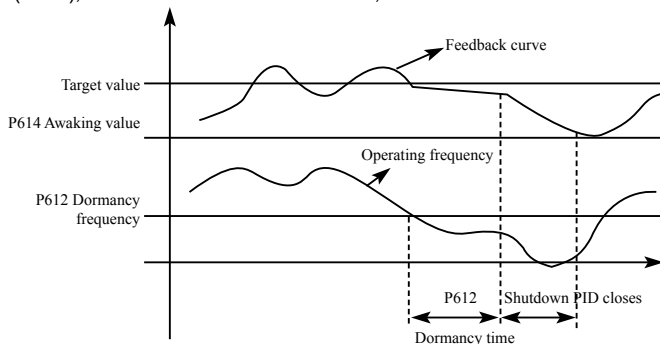

Example: PID action set point is 60% (0 – 100% is corresponding to 0 – 10V), and the wake-up value is 80%, which is actually corresponding to 0 – 10V, then the actual wake-up value is $60\% \times 80\% = 48\%$ (corresponding to 0 – 10V).

P614	PID corresponding value of display		Initial value : 1000	
	Setting range	0 – 1000	Unit	1
P615	PID digit of display		Initial value : 4	
	Setting range	0 – 5	Unit	1
	0: Not display PID feedback value 1: Display 1 digit 2: Display 2 digits		3: Display 3 digits 4: Display 4 digits 5: Display 5 digits	
P616	PID decimal digit of display		Initial value : 1	
	Setting range	0 – 4	Unit	1
	Content:	0: Not display after decimal point 1: Display 1 digit after decimal point 2: Display 2 digits after decimal point 3: Display 3 digits after decimal point 4: Display 4 digits after decimal point		

P614 PID corresponding value of display.

P614 setting value is corresponding to + 10V analog voltage.

If P614 is set as 200, then it indicates that full span is 200, corresponding to + 10V voltage.

P615 sets the digit display.

0 indicates not displaying feedback value. Users may select the digit displayed according to actual need.

P616 PID decimal digit of display.

P616 sets the digit displayed after decimal point.

For example: Four-digit display is required, with 1 digit displayed after decimal point, target value is set as 50%, and PID corresponding value of display is 200.

Then, the display value is $200 \times 50\% = 100.0$ and the parameter

group is convenient for users to monitor.

Parameter: P614 = 200; P615 = 4; P616 = 1.

7-8 Initial settings and specifications of RS-485 communication

Used to perform required setting for communication between the inverter and personal computer.

P700	RS-485 Communication speed		Initial value : 0	
	Setting range	0 – 3	Unit	1
	Content:	0: 4800bps 2: 19200bps	1: 9600bps 3: 38400bps	

For example, the communication speed is 19200bps when the setting value is “2”.

P701	Communication mode		Initial value : 0	
	Setting range	0 – 5	Unit	1
	Content:	0: 8N1 For ASCII 2: 8E1 For ASCII 4: 8O1 For RTU	1: 8O1 For ASCII 3: 8N1 For RTU 5: 8E1 For RTU	

P701 sets the format of communication data. Please see related communication specification in detail.

P702	RS-485 communication station		Initial value : 0	
	Setting range	0 – 240	Unit	1

Each inverter must have a station number, which will be defined through P702. Communication control of inverter can connect with 240 others.

If P702 is set to “0”, means communication function is invalid.

H2000 series MODBUS communication protocol

H2000 series communication agreement is with MODBUS ASCII (American standard code for information inter change) mode: Each byte consists of 2 ASCII characters, for example: The expression

of the numerical value of 54Hex ASCII is that “54” consists of “5” (35Hex) and 4(34 Hex).

1. Definition of coding

Communication agreement belongs to hexadecimal system, of which each character represents the following information.

Character	“0”	“1”	“2”	“3”	“4”	“5”	“6”	“7”
ASCII code	30H	31H	32H	33H	34H	35A	36A	37A
Character	“8”	“9”	“A”	“B”	“C”	“D”	“E”	“F”
ASCII code	38A	39H	41H	42H	43A	44A	45H	46H

2. Character structure

10 – Bit character box (For ASCII)

Data pattern: 8N1 For ASCII

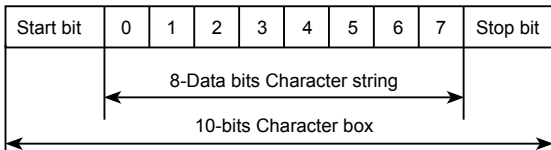

10 – Bit character box (For RTU)

Data pattern: 8N1 For RTU

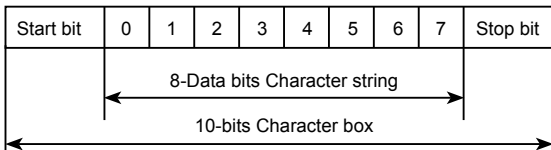

Data pattern: 8O1 For ASCII

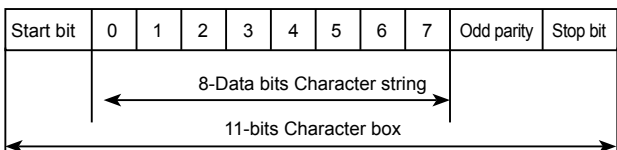

Data pattern: 8E1 For ASCII

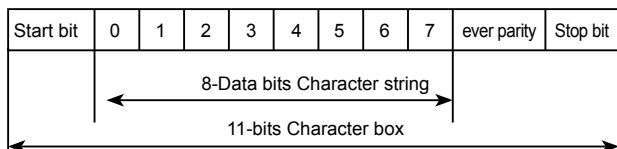

Data pattern: 8O1 For RTU

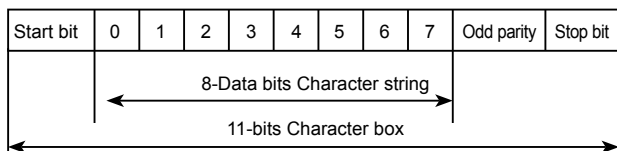

Data pattern: 8E1 For RTU

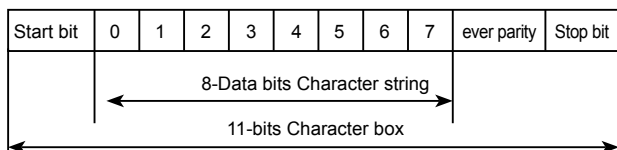

3. Structure of communication data

Data format box

ASCII mode:

STX	Start character = ':'(3AH)
Address Hi	Communication address:
Address Lo	8-bit address consists of 2 ASCII codes
Function Hi	Function code:
Function Lo	8-bit function code consists of 2 ASCII codes
DATA (n-1)	Data characters:
.....	$n \times 8$ -bit data content consists of $2n$ ASCII codes
DATA 0	$n \leq 16$, with the maximum of 32 ASCII codes

LRC CHK Hi	LRC Check:
LRC CHK Lo	8-bit LRC Check consists of 2 ASCII codes
END Hi	End character:
END Lo	END Hi = CR (0DH), END Lo = LF (0AH)

RTU mode:

START	Keep that zero-input signal is more than or equal to 10 ms
Address	Communication address: 8-bit binary address
Function	Function code: 8-bit binary address
DATA (n-1)	Data characters: n × 8-bit data, n = 16
.....	
DATA 0	
CRC CHK Low	CRC Check:
CRC CHK High	16-bit CRC Check consists of 2 8-bit binary systems
END	Keep that zero-input signal is more than or equal to 10 ms

Communication Address

00H: All driver Broadcasts

01H: For inverter with 01st address

0FH: For inverter with 15th address

10H: For inverter with 16th address, by analogy, the maximum could reach 240.

Function code and Data Characters

03H: Read out the content of temporary storage

06H: Write a WORD into temporary storage; Function code 03H:

Read out the content of temporary storage.

For example: Driver address 01H, reads out the data characters in 2 successive temporary storages as follows: Initial temporary storage address 2102H

Function code 06H: Write a WORD into temporary storage.

Format of enquiry message character string:

STX	':'
Address	'1'
	'0'
Function	'0'
	'3'
Starting address	'2'
	'1'
	'0'
	'2'
Number of data (count by word)	'0'
	'0'
	'0'
	'2'
LRC Check	'D'
	'7'
END	CR
	LF

Format of response message character string:

STX	':'
Address	'0'
	'1'
Function	'0'
	'3'
Number of data (count by byte)	'0'
	'4'
Content of starting address 2102H	'1'
	'7'
	'7'
	'0'
Content of address 2103 H	'0'
	'0'
	'0'
	'0'
LRC Check	'7'
	'1'
END	CR
	LF

ASCII mode:

RTU mode:

Format of enquiry message:

Address	01H
Function	03H
Starting data address	21H
	02H
Number of data (count by word)	00H
	02H
CRC CHK Low	6FH
CRC CHK High	F7H

Format of response message:

Address	01H
Function	03H
Number of data (count by byte)	04H
Content of data address 8102H	17H
	70H
Content of data address 8103H	00H
	00H
CRC CHK Low	FEH
CRC CHK High	5CH

For example: Driver address 01H, writes 6000 (1770H) into the internal setting parameter 0100H of driver.

LRC Check of ASCII mode

ASCII mode:

Format of enquiry message character string:

STX	'.'
Address	'0'
	'1'
Function	'0'
	'6'
Data address	'0'
	'1'
	'0'
	'0'
Data content	'1'
	'7'
	'7'
	'0'
LRC Check	'7'
	'1'
END	CR
	LF

Format of response message character string:

STX	'.'
Address	'0'
	'1'
Function	'0'
	'6'
Data address	'0'
	'1'
	'0'
	'0'
Data content	'1'
	'7'
	'7'
	'0'
LRC Check	'7'
	'1'
END	CR
	LF

RTU mode:

Format of enquiry message:

Address	01H
Function	06H
Data address	01H
	00H
Data content	17H
	70H
CRC CHK Low	86H
CRC CHK High	22H

Format of response message:

Address	01H
Function	06H
Data address	01H
	00H
Data content	17H
	70H
CRC CHK Low	86H
CRC CHK High	22H

LRC Check is the value added from Address to Data Content. For example, the LRC Check of the above 3.3.1 enquiry message is as: $01H + 03H + 21H + 02H + 00H + 02H = 29H$, then the complement of 2 (D7H) is taken.

CRC Check of RTU mode

CRC Check is from Address to Data content, and its running rule is as follows:

Step 1: Make 16-bit temporary storage (CRC temporary storage) = FFFFH.

Step 2: Exclusive OR first 8-bit byte message instruction and low 16-bit CRC temporary storage: Perform Exclusive OR, and store the result into CRC temporary storage.

Step3: Move CRC temporary storage one more bit, and fill 0 into high bit position.

Step 4: Check right shift value, if being 0, store the new value for step 3 into CRC temporary storage, otherwise in case of Exclusive OR A001H and CRC temporary storage, store the result into CRC temporary.

Step 5: Repeat Step 3 ~ Step 4, and operate completely for 8-bit.

Step 6: Repeat Step 2 ~ Step 5, and take the message instruction for next 8-bit, till all message instructions are operated completely.

Finally, the value gotten of CRC temporary storage is CRC Check. It is noteworthy that, CRC Check must be placed into the check mode of message instruction interchangeably.

The following is the example of CRC Check running written in C language:

```
Unsigned char * data ←//Message instruction pointer
```

```
Unsigned char length ←//Length of message instruction
```

```

unsigned int crc_chk (unsigned char*data, unsigned char length)
{
    int j;
    unsigned int reg_crc=0xffff;
    while( length-- ) {
        reg_crc^=*data ;
        for (j = 0; j<8; j ) {
            if (reg_crc & 0x01) { /*LSB (b0) =1 */
                reg_crc= (reg_crc>>1) ^0xa001;
            }else{
                reg_crc=reg_crc>>1;
            }
        }
    }
    return reg_crc; //Finally feedback the value of CRC temporary storage
}

```

7-9 Advanced application parameters

P800	Advanced application parameter lock		Initial value: 1	
	Setting range	0 – 1	Unit	1
	content	0: Lock 1: Unlock		

If P800 is set to “0”, you can not use the advanced parameters.

P801	System 50Hz/60Hz selection		Initial value: 0	
	Setting range	0 – 1	Unit	1
	content	0: 50Hz 1: 60Hz		

50Hz/60Hz system could be set via the parameter according the condition of electric network.

P802	constant and variable torque selection		Initial value : 0	
	Setting range	0 – 1	Unit	1
	content	0: Constant torque 1: Variable torque		

For fan and pump load, you can select “variable torque” for better energy saving.

P803	Overvoltage protection setting		Initial value: change	
	Setting range	760 – 820	Unit	1

P803 sets DC-bus overvoltage protection level. This function could be used to avoid over voltage protection during deceleration.

P804	Undervoltage protection setting		Initial value: change	
	Setting range	380 – 450	Unit	1

P804 sets voltage protection level.

If the input voltage is low, inverter is easy to trip for undervoltage.

This function could be used to avoid inverter protection undervoltage

P805	Over temperature protection setting		Initial value: change	
	Setting range	40 – 120	Unit	1

P805 sets the over temperature protection level of inverter. In high temperature environment, the protection level could be improved appropriately, to guarantee the normal running of inverter. However, too high setting value will result in IGBT damage, so the only solution is to improve the effect of heat elimination, so as to achieve the goal of cooling-down.

P806	Current display filter time		Initial value : 2.0	
	Setting range	0 – 100	Unit	1

This parameter setting is relevant to the stabilization of current display, and shall not be modified in general. If the setting is too small, current display will fluctuate.

P807	0-10V analogue output low end calibration coefficient		Initial value : *	
	Setting range	0 – 65535	Unit	1

Chapter 7 Detailed Explanations of Functional Parameters

P808	0-10V analog output high end calibration coefficient Initial value : *			
	Setting range	0 – 65535	Unit	1
P809	0-20mA analogue output low end calibration coefficient Initial value: *			
	Setting range	0 – 65535	Unit	1
P810	0-20mA analog output high end calibration coefficient Initial value: *			
	Setting range	0 – 65535	Unit	1

The above parameters are factory default setting, normally shall not be adjusted, otherwise it may cause abnormal operation.

Chapter 8

Precautions for Maintenance and Inspection

The inverter is a static unit mainly consisting of semiconductor devices. Daily inspection must be performed to prevent any fault from occurring due to the adverse effects of the operating environment. Such as temperature, humidity, dust, dirt and vibration, changes in the parts with time, service life, and other factors.

• Precautions for maintenance and inspection

For some short time after the power is switched off, a high voltage remains in the smoothing capacitor. When accessing the inverter for inspection, wait for at least 10 minutes after the power supply has been switched off, and then make sure that the voltage across the main circuit terminals P/+--N/- of the inverter is not more than 30VDC using a tester, etc.

8-1 Inspection

8-1-1 Daily inspection

Basically, check for the following faults during operation.

- (1) Motor operation fault
- (2) Improper installation environment
- (3) Cooling system fault
- (4) Unusual vibration and noise
- (5) Unusual overheat and discoloration

During operation, check the inverter input voltages using a tester.

8-1-2 Periodic inspection

Check the areas inaccessible during operation and requiring

periodic inspection.

Consult us for periodic inspection.

- (1) Check for cooling system fault Clean the air filter, etc.
- (2) Tightening check and retightening.....The screws and bolts may become loose due to vibration, temperature changes, etc.
- (3) Check the conductors and insulating materials for corrosion and damage.
- (4) Measure insulation resistance.
- (5) Check and change the cooling fan and relay.

8-1-3 Daily and periodic inspection

Inspection item	Description	Corrective Action at Alarm Occurrence
Surrounding environment	Check the ambient temperature, humidity, dirt, corrosive gas, oil mist, etc.	Improve environment
Overall unit	Check for unusual vibration and noise	Check alarm location and retighten
Power supply voltage	Check that the main circuit voltages and control voltages are normal.	Inspect the power supply
General	<ol style="list-style-type: none"> 1. Check with megger (across main circuit terminals and earth terminal). 2. Check for loose screws and bolts. 3. Check for overheat traces on the parts. 4. Check for stain 	Contact the manufacturer Retighten Contact the manufacturer Clean
Aluminum electrolytic capacitor	<ol style="list-style-type: none"> 1. Check for liquid leakage in a capacitor and deformation trace 2. Visual check and judge by the life check of the control circuit capacitor. 	Contact the manufacturer
Cooling system	Air filter, fan, etc.	Clean
Load motor	Check for vibration and abnormal increase in operation noise	Stop the device and contact the manufacturer

8-2 Replacement of parts

The inverter consists of many electronic parts such as semiconductor devices.

The following parts may deteriorate with age because of their structures or physical characteristics leading to reduced performance or fault of the inverter. For preventive maintenance, the parts must be replaced periodically.

Use the life check function as a guidance of parts replacement.

Part name	Standard replacement interval	Description
Cooling fan	3-5 years	Replace (as required)
Smoothing capacitor	5 years	Replace (as required)
Fuse (18.5kw or more)	10 years	Replace (as required)
Relays	---	as required

Replacement years for when the yearly average ambient temperature is 40°C (Without corrosive gas, flammable gas, oil mist, dust and dirt etc.)

8-3 Trouble shooting

When an alarm (major failures) occurs in the inverter, the protective function is activated bringing the inverter to an alarm stop and the operation panel display automatically changes to any of the following error (alarm) indications.

If your fault does not correspond to any of the following errors or if you have any other problem, please contact your sales representative.

- Alarm display..... when the protective function is activated, the operation panel display automatically switches to the above indication.
- Resetting method.....when the protective function is activated, the inverter output is kept stopped. Unless reset, therefore, the

inverter cannot restart.

- When the protective function is activated, take the corresponding corrective action, then reset the inverter, and resume operation.

Not doing so may lead to the inverter fault and damage.

List of alarm display

Operation Panel Indication	Name	Possible fault reason	Corrective action
OC0 / UC0	Over current during stop	1: Inverter fault	Please contact your sales representative.
OC1/UC1	Over current during acceleration	1: Acceleration time is too short 2: V/F curve is not set correctly 3: Motor or motor wire have short circuit to the ground 4: The torque boost is set too fast 5: The input voltage is too low 6: Directly start up the running motor 7: The inverter setting is not correct 9: The inverter fails	1: Increase acceleration time 2: Correctly set V/F curve. 3: Check the insulation of motor and motor wire. 4: Reduce the value of torque boost. 5: Check input voltage 6: Check the load 7: Set tracing startup 8: Enlarge capacity of inverter 9: Sent for repairing
OC2 / UC2	Over current during deceleration	1: Decelerate time is too short 2: Inverter capacity is inappropriately set 3: Whether there is any disturbing	1: Increase deceleration time 2: Enlarge inverter capacity 3: Solve disturbing resource
OC3 / UC3	Over current during constant speed	1: The insulation of motor and motor wire is not good 2: Load fluctuation 3: Fluctuation of input voltage and the voltage is low 4: Inverter capacity is inappropriately set 5: Whether there is a large power motor starting up and leads the input voltage goes down 6: Whether there is a disturbing resource to disturb inverter	1: Check the insulation of motor and motor wire 2: Check load situation and mechanical lubrication 3: Check input voltage 4: Enlarge the capacity of inverter 5: Increase capacity of transformer 6: Solve disturbing resource

Operation Panel Indication	Name	Possible fault reason	Corrective action
OU0	Over voltage during stop	1: The deceleration time is short 2: Inverter capacity incorrectly set 3: Disturbing	1: Check the power supply voltage 2: Sent for repairing
OU1	Over voltage during acceleration	1: Abnormal power supply 2: Peripheral circuitry is incorrectly set (switch control on or off, etc.) 3: Inverter fault	1: Check the power supply voltage 2: Do not use power supply switch to control the inverter on or off 3: Sent for repairing
OU2	Over voltage during deceleration	1: Power supply voltage abnormal 2: Energy feedback load 3: Braking resistor incorrectly set	1: Check the power supply voltage 2: Install braking unit and resistance 3: Affirm resistance setting again
OU3	Over voltage during constant speed	1: Decelerate time is too short 2: Power supply voltage abnormal 3: Over load 4: Braking resistor incorrectly set 5: Braking parameter is incorrectly set	1: Increase deceleration time 2: Check the power supply voltage 3: Check braking unit and resistance 4: Set Braking resistor over again 5: Correctly set parameter, e.g. braking tube voltage, etc.
LU0	Under voltage during stop	1: Power supply voltage abnormal 2: Phase missing	1: Check the power supply voltage 2: Check power supply and switch whether there is phase missing
LU1	Under voltage during acceleration	1: Power supply voltage abnormal 2: Phase missing 3: There is large load power start up in the input	2: Check whether peripheral setting bad connection leads phase missing 3: Please use independent power supply
LU2	Under voltage during deceleration		
LU3	Under voltage during constant speed		

Operation Panel Indication	Name	Possible fault reason	Corrective action
Fb0	Fuse broken	1: The inverter fault	Please contact your sales representative.
Fb1			
Fb2			
Fb3			
OL0 during stop	Inverter overload	1: Overload 2: Acceleration time is too short 3: Torque boost is too fast 4: V/F curve incorrectly set 5: Under voltage of input 6: Before motor stops, inverter starts up 7: Fluctuation or blocking in loading	1: Reduce the load weight or replace larger capacity inverter. 2: Increase acceleration time 3: Reduce torque boost rate 4: Set V/F curve over again 5: Check input voltage, increase inverter capacity 6: Adopt tracing startup mode 7: Check load condition
OL1 during acceleration			
OL2 during deceleration			
OL3 during constant speed			
OT0 during stop	Motor overload	1: The motor for use under overload 2: Acceleration time is too short 3: Motor protection setting is too small 4: V/F curve is incorrectly set 5: Torque boost is too fast 6: Bad motor insulation 7: Motor setting is too small	1: Reduce the load weight. 2: Increase acceleration time 3: Increase protection setting 4: Correctly set V/F curve 5: Reduce torque boost rate 6: Check motor insulation and replace motor 7: Use larger inverter or motor
OT1 during acceleration			
OT2 during deceleration			
OT3 during constant speed			
OH0 during stop	Inverter overheat	1: Cooling fan broken 2: Heatsink clogging 3: The ambient temperature is high	1: Replace the cooling fan. 2: Clean thr heatsink 3: Set the ambient temperature to within the specifications.
OH1 during acceleration			
OH2 during deceleration			
OH3 during constant speed			

Operation Panel Indication	Name	Possible fault reason	Corrective action
ES	Emergency stop	1: Inverter is in Emergency stop condition	1: After release Emergency stop, start up as regular procedure
CO	Communication error	1: Communication line connection has problem 2: Communication parameter is incorrectly set 3: Transmission format is wrong	1: Perform wiring of the RS-485 terminals properly. 2: Set parameter over again 3: Check data transmission format
20	4-20mA wire broken	1: Terminal is loose; signal input line is bad connected	1: Perform wiring of the 4-20mA terminals properly.
Pr	Parameter write error	Parameter setting is wrong	After stopping operation, make parameter setting.
Err	Wrong parameter group	The parameter does not exist or the factory setting parameter	Quit this parameter

8-3 Check first when you have troubles

If the causes is still unknown after every check, it is recommended to initialize the parameters (initial value) then reset the required parameter values and check again.

(1) Parameter write cannot be performed

Causes and corrective actions :

a: Check P118 parameter write selection.

b: Check P101Frequency setting/P102 Operation mode setting selection.

c: Make sure that operation is not being performed. Please stop the inverter and set.

(2) Motor does not rotate as commanded

Causes and corrective actions:

a: Check that the P102 Operation mode selection setting is correct.

b: Check that the starting frequency setting is not greater than the running frequency.

- c: Check the main circuit and control circuit.
- d: Check that the output stop signal or reset signal is not on.
- e: Check that P104 Reverse rotation prevention selection is not selected.
- f: Check that frequency setting of each running frequency (such as multi-speed operation) are not zero.
- g: Check that especially the P105 Maximum frequency setting is not zero.
- h: Check that the P400 Jog frequency setting is not lower than the P202 starting frequency setting.
- i: Check that the load is not too heavy.

(3) Motor generates heat abnormally

Causes and corrective actions:

- a: Check that the load is not too heavy. Lighten the load.
- b: Is the fan for the motor is running ? (check for accumulated dust.)
- c: Check that the P208 Torque boost setting is correct.
- d: Was the motor type set? Check the setting of P209 to P219 applied motor.
- e: When using any other manufacturer's motor ,perform offline auto tuning.

(4) Motor generates abnormal noise

Causes and corrective actions:

- a: No carrier frequency noises (metallic noises) are generated.
Check the setting of P115 applied motor.
- b: Check for any mechanical looseness.
- c: Contact the motor manufacturer.

(5) Motor rotates in opposite direction

Causes and corrective actions:

- a: Check that the phase sequence of output terminals U,V and W is correct.
- b: Check that the start signals (forward rotation, reverse rotation) are connected properly.

(6) Speed does not increase

Causes and corrective actions:

a: Check that the maximum frequency (P105) setting is correct. (If you want to run the motor at 120Hz or more, set P105 High speed maximum frequency.)

b: Check that the load is not too heavy. (In agitators, etc, load may become heavier in winter.)

c: Check that the brake resistor is not connected to terminals P/+ -P/- accidentally.

(7) Inverter may interfere with other devices.

Causes and corrective actions:

The input/output (main circuit) of the inverter includes high frequency components, which may interfere with the communication devices used near the inverter. In this case, set EMC filter valid to minimize interference.

a: Decrease carrier frequency (P115).

b: Install a noise filter on the inverter output side to reduce the electromagnetic noise generated from the inverter.

c: Install a noise filter on the inverter input side.

d: For reduction of induction noise from the power line of the inverter, it is recommended to wire the earth cable by returning it to the earth terminal of the inverter.

e: To prevent a malfunction due to noise, keep the signal cables more than 10cm away from the power cables.

f: Control circuit cable should use shielded cable, and the cable should be installed in metal tube

8-4 Inverter-generated noises and their reduction techniques

Some noises enter the inverter to malfunction it and others are radiated by the inverter to malfunction peripheral devices. Though the inverter is designed to be insusceptible to noises, it handles

low-level signals, so it requires the following basic techniques. Also, since the inverter chops outputs at high carrier frequency, that could generate noises. If these noises cause peripheral devices to malfunction, measures should be taken to suppress noises. These techniques differ slightly depending on noise propagation paths.

① Basic techniques

- Do not run the power cables (I/O cables) and signal cables of the inverter in parallel with each other and do not bundle them.
- Use twisted pair shielded cables for the detector connection and control signal cables, and connect the sheathes of the shield cables to terminal SC.
- Earth the inverter, motor, etc, at one point.

② Techniques to reduce noises that enter and malfunction the inverter

When devices that generate many noises (which use magnetic contactors, magnetic brakes, many relays, for example) are installed neat the inverter and the inverter may be malfunctioned by noises, the following measures must be taken:

- Provide surge suppressors for devices that generate many noises to suppress noises.
- Fit data line filters to signal cables.
- Earth the shields of the detector connection and control signal cables with Cable clamp metal.

③ Noise reduction examples

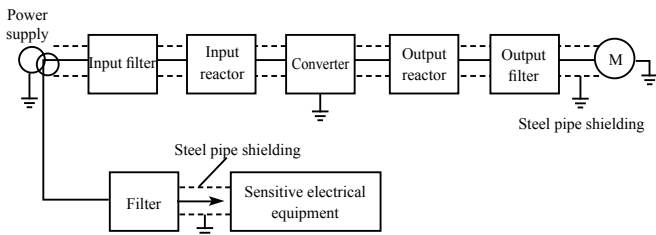

Chapter 9

Peripheral Devices Selection

Check the motor capacity of the inverter you purchased. Appropriate peripheral devices must be selected according to the capacity. Refer to the following list and prepare appropriate peripheral devices:

9-1 Peripheral Devices Description

Peripheral Devices Name	Description
Moulded case circuit break (MCCB) or earth leakage circuit break (ELB),fuse	The breaker must be selected carefully since an In-rush curreH flows in the inverter at power on.
Magnetic coFactor (MC)	Install the MC to ensure safety. Do not use this MC to start and stop the inverter. Doing so will cause the inverter life to be shorten.
AC/DC Reactor	Reactor (option) should be used when power harmonics measures are taken, the power factor is to be improved or thr inverter is installed near a large power supply system (1000KVA or more). The inverter may be damaged if you do not use reactors. Select the reactor according to the model. For the 160KW or less, remove the jumpers across terminals P/+--P/-to connect to the DC reactor. For the 185KW or more , a DC reactor is supplied. Please always install the reactor.
Noise filter	Install a noise filter to reduce the electromagnetic noise generated from the inverter. Effective in the rang from about 1MHz to 10MHz. When more wires are passed through, a more effective result can be obtained.

Brake resistor and brake unit	To improve the brake capability at deceleration.
Ferrite ring	To reduce the disturbance which is generated by inverter

9-2 Applied Braking resistor Specification

Applicable Inverter Type	Brake resistor		Brake Torque (10% ED)	Motor Output (kW)	Remark
	Power (W)	Resistance value Ω			
H2200A00D4K	80	200	125	0.4	
H2200A0D75K	100	200	125	0.75	
H2200A01D5K	300	100	125	1.5	

Calculate of Braking resistor value:

The Braking resistor value is related to the DC currency when the inverter braking. For 380V power supply, the braking DC voltage is 800V-820V, and for 220V system, the DC voltage is 400V.

Moreover, the Braking resistor value is related to braking torque $M_{br}\%$, and to the differeH braking torque the Braking resistor values are differeH, and the calculation formula is as follow:

$$R = \frac{U_{dc}^2 \times 100}{P_{Motor} \times M_{br}\% \times \eta_{Transducer} \times \eta_{Motor}}$$

Thereinto: U_{dc} — Braking DC voltage;

P_{Motor} — Motor power;

M_{br} — Braking torsion;

η_{Motor} — Motor dfficiency;

$\eta_{Transducer}$ — Transducer efficiency.

The braking power is related to braking torque and braking frequency. the foregoing illustration gives the braking torque as 125% and the frequency is 10%, and according to the differeH loading situations, the numbers in the illustration are for reference.

Appendix 1

Simple Application Example

Three-wire Type Connecton Example

A three-wire type connection is shown below:

A: Basic connection illustration:

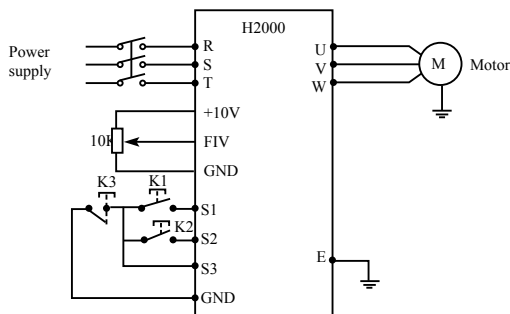

B: Parameter setting and instruction:

P101=1 Analog voltage input as frequency setting (external potentiometer)

P102=1 External terminal control

P317=6 The forward rotation start signal is assigned to the terminal S1.

P318=7 The reverse rotation start signal is assigned to the terminal S2.

P319=8 The stop signal is assigned to the terminal S3.

C: Action instruction:

Appendix 1 Simple Application Example

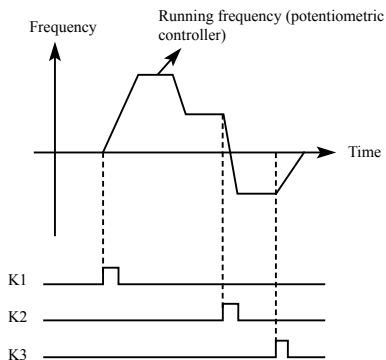

K1 forward rotation

K2 reverse rotation

K3 Stop

Output frequency is controlled by potentiometer.



GUANG ZHOU HAITEC TRANSMISSION EQUIPMENT CO., LTD

2010.10